

United States
Department of
Agriculture



Forest Service
Southern Region

A GUIDE FOR PRESCRIBED FIRE IN SOUTHERN FORESTS



February 1989
Technical Publication R8-TP 11

PRESCRIBED BURNING IS FIRE...

- Applied in a skillful manner
- Under exacting weather conditions
- In a definite place
- To achieve specific results

The Objective of this Prescribed Burning Guide

To help resource managers plan and execute prescribed burns in Southern forests by:

- Explaining the reasons for prescribed burning.
- Emphasizing the environmental effects.
- Explaining the importance of weather in prescribed burning.

- Describing the various techniques of prescribed burning.
- Giving general information pertaining to prescribed burning.

A GUIDE FOR PRESCRIBED FIRE IN SOUTHERN FORESTS



Backing fire in young slash pine

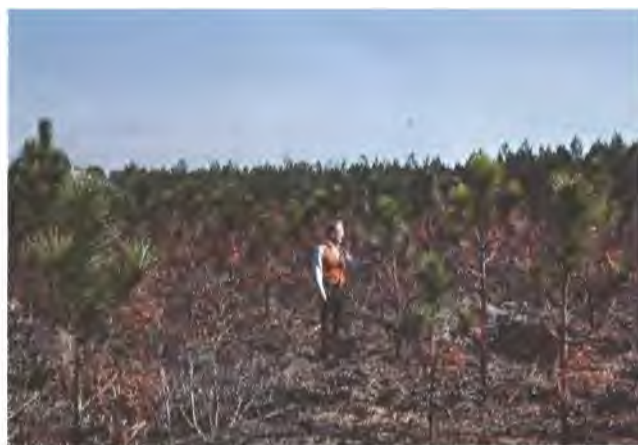

Postburn results

Rewritten in 1988 by Dale D. Wade, Southeastern Forest Experiment Station; and James D. Lunsford, Fire Management, Southern Region, USDA Forest Service

Originally written in 1966 by Merlin J. Dixon, Southern Region, USDA Forest Service.

1973-1979 revisions, lead author Hugh E. Mobley, Southern Region, USDA Forest Service.

Photo assistance was provided by the Alabama Forestry Commission; Georgia Forestry Commission; North Carolina Forest Service; USD1 Fish and Wildlife Service, Piedmont National Wildlife Refuge; South Carolina Commission of Forestry; Southeastern Forest Experiment Station, Southern Region, and Southern Forest Experiment Station, USDA Forest Service; Tall Timbers Research Station; Union Camp Corporation; and Westvaco Corporation.

Appreciation is expressed to the various State and Federal agencies, private industries and other organizations for their helpful reviews and cooperation.

This guide provides basic information needed to help you become technically proficient in the proper use of prescribed fire. A glossary toward the end of this manual will help you with unfamiliar terms. To learn more about the subject of prescribed fire, a list of suggested reading follows the glossary. Nearby State and Federal resource management agencies are also excellent sources of information. Many of these agencies provide periodic training in fire behavior and prescribed fire.

Contents

	PAGE
INTRODUCTION	1
The Ecology of Fire	1
Prescribed Fire History	1
Present Use	2
Impact of Prescribed Burning	2
REASONS FOR PRESCRIBED FIRE IN FOREST RESOURCE MANAGEMENT	3
Reduce Hazardous Fuels	3
Dispose of Logging Debris	4
Prepare Sites For Seeding or Planting	4
Improve Wildlife Habitat	4
Manage Competing Vegetation	5
Control Insects and Disease	5
Improve Forage For Grazing	6
Enhance Appearance	6
Improve Access	7
Perpetuate Fire-dependent Species	7
ENVIRONMENTAL EFFECTS	8
Vegetation	8
Soil	9
Water	10
Air	10
Human Health and Welfare	11
Wildlife	11
Aesthetics	12
WEATHER AND FUEL CONSIDERATIONS	13
Important Weather Elements	13
Sources of Weather Information	14
Wind	14
Underburning	14
Debris burning	15
Relative Humidity	15
Underburning	15
Debris burning	15
Temperature	16
Underburning	16
Debris burning	16
Rainfall and Soil Moisture	16
Underburning	16
Debris burning	16
Fine-Fuel Moisture	16
Underburning	16
Debris burning	17
Airmass Stability and Atmospheric Dispersion	18
Underburning	18
Debris burning	18
FIRING TECHNIQUES	20
General	20
Backing Fire	21
Factors Associated with Backing Fires	21

Strip-heading Fire	22
Factors Associated with Strip-heading Fires	22
Flanking Fire	23
Factors Associated with Flanking Fires	23
Point Source Fires	24
Factors Associated with Point Source Fires	25
Aerial Ignition	25
Factors Associated with Aerial Ignition	25
Factors Associated with Ping-pong Ball (DAID) System	26
Factors Associated with Helitorch System	26
Center and Circular (Ring) Firing	27
Pile and Windrow Burning	27
Factors Associated with Pile and Windrow Burning	28
<i>SMOKE MANAGEMENT</i>	29
Table 1. – Relationship of Dispersion Index to On-the-ground Burning Conditions	29
Table 2. – Effect of Smoke Concentration on Visibility	30
Screening System For Managing Smoke	30
<i>PLANNING THE PRESCRIBED BURN</i>	33
The Written Plan	33
Table 3. – Effects of Age of Rough on Some Common Fire Parameters	33
Simple Understory Prescribed Burning Unit Plan	34
Understory Prescribed Burning Unit Plan	35
Postharvest Prescribed Burning Unit Plan	36
<i>PREPARING FOR THE PRESCRIBED BURN</i>	41
Steps to be Considered	41
Establishing Control Lines	41
After Plow Lines Are Established	41
Burning-unit Map	41
<i>EXECUTING THE BURN</i>	42
Checklist	43
<i>EVALUATING THE BURN</i>	44
Indications and Guidelines	44
Needle Scorch	44
Soil and Root Damage	44
Air Quality	44
Timing and Points to Evaluate	45
<i>COORDINATION OF BURNING</i>	46
<i>RULES OF THUMB</i>	48
<i>RED FLAG SITUATIONS</i>	49
<i>GLOSSARY</i>	50
<i>SUGGESTED READING</i>	54



Palmetto-gallberry fuel type prior to prescribed burn



Postburn results

introduction

The Ecology of Fire

Fire has played a major role in determining the distribution of plants across the South. Some plant communities such as cypress swamps survive for centuries between prolonged droughts that finally allow stand-replacement fires to enter. Other communities such as the once vast expanse of longleaf pine burn every few years. In fact some ecosystems, for example the longleaf pine-wiregrass association, require periodic fire for their very survival.

A basic premise of fire ecology is that wildland fire is neither innately destructive nor constructive: it simply causes change. Whether these changes are viewed as desirable or not depends upon their compatibility with one's objectives. Irrespective of man's view-

point, change is biologically necessary to maintain a healthy ecosystem. Resource managers have learned to manipulate fire-caused changes in plant and animal communities to meet their needs, and those of humankind in general, while at the same time preserving underlying natural processes and functions. They do this by varying the timing, frequency, and intensity of fire.

Prescribed Fire History

The use of fire in the forests of the United States has come full cycle. Early settlers found Indians using fire in virgin pine stands and adopted the practice themselves to provide better access, improve hunting, and to get rid of brush and timber so they could farm. Annual burning to "freshen up"

southern range became a custom. This practice, plus destructive wildfires after logging left millions of acres of forest land in the south devoid of trees.

The increasing wildfire problem coupled with the need for a fire-free interval of several years to allow the pines to become reestablished led many foresters to advocate the exclusion of all fire from the woods. Others, however, pointed out that fire might have a place in the management of longleaf pine. Fire has been used by professional foresters to reduce hazardous fuels since the turn of the century. The misconceptions and controversy surrounding the deliberate use of fire to achieve resource management objectives have slowly been replaced by facts. As knowledge accumulated, the use of prescribed fire grew.



Depression-era photo of unproductive forest land



Grid ignition



Smoke obscuring highway

Present Use

Today prescribed fire is applied to roughly 8 million acres in the South each year — about half of which are burned to achieve various forest management objectives. Most of the remainder is for range and agricultural purposes. Prescribed burning is a desirable and economically sound practice on most southern pine sites. In many cases, prescribed burning is the only practical choice. Few, if any, alternative treatments have been developed that can compete with fire from the standpoint of effectiveness and cost. Chemical applications generally cost more than 10 times as much per acre as prescribed fire. Mechanical treatments such as disk-ing, chopping, or raking are at least 20 times more expensive. Each of these three alternatives also has associated environmental costs, such as destruction of habitat and soil erosion. Both the probability of causing damage, and the magnitude of such damage, should it occur, need to be kept in mind.

In this guide, *prescribed burning is defined as fire applied in a knowledgeable manner to forest fuels on a specific land area under selected weather conditions to accomplish predetermined, well-defined management objectives.*

This manual will be most useful in the lower Piedmont and Coastal Plain. Prescribed burning in these areas has been perfected by several generations of resource managers. Although the potential of prescribed fire in the upper Piedmont and mountains of the South has been demonstrated, few guidelines exist. If you are interested in the emerging use of fire in the mountains, a good source of information and help is your local State or Federal forestry office.

Impact of Prescribed Burning

A single prescribed burn can achieve multiple benefits. For example a prescribed burn that consumes more dead fuel than it creates will reduce the fire hazard and, with few if any modifications, will also improve wildlife habitat. Almost any prescribed burn improves access.

Prescribed fires aren't always beneficial, however. When conditions are wrong, prescribed fire can severely damage the very resource it was intended to benefit. Prescribed fire can temporarily reduce air quality, but usually to a much lesser degree than wildfire. For every prescribed fire opportunity, there are tradeoffs that should be recognized and carefully weighed before a decision is reached. Proper planning and execution are

necessary to minimize any detrimental effects to air quality. Potential off-site impacts such as downstream water quality should be carefully considered, as should on-site impacts to soil and aesthetics.

Public opinion is another factor to consider because the general public is concerned about the deterioration of the environment. Smoke from prescribed fires, as well as from wildfires, is highly visible. It is our job as resource managers to inform the public of the differences between prescribed fire and wildfire—which often look identical to the untrained eye.

Prescribed fire is a complex tool and should be used only by those trained in its use. Proper diagnosis and detailed planning are needed for every area where burning is contemplated. The incomplete assessment of any factor can pose serious liability questions should the fire escape or its smoke cause damage. A prescribed fire that does not accomplish its intended objective(s) is a loss of both time and money, and it may be necessary to reburn as soon as sufficient fuel accumulates. Keep in mind that some resource management objectives can be met with a single fire, some require several fires in fairly quick succession, and some can only be accomplished by burning periodically throughout the rotation.

Reasons

For Prescribed Fire In Forest Resource Management

- Reduce hazardous fuels
- Prepare sites for seeding and planting
- Dispose of logging debris
- Improve wildlife habitat
- Manage competing vegetation
- Control disease
- Improve forage for grazing
- Enhance appearance
- Improve access
- Perpetuate fire-dependent species
- Cycle nutrients
- Manage endangered species

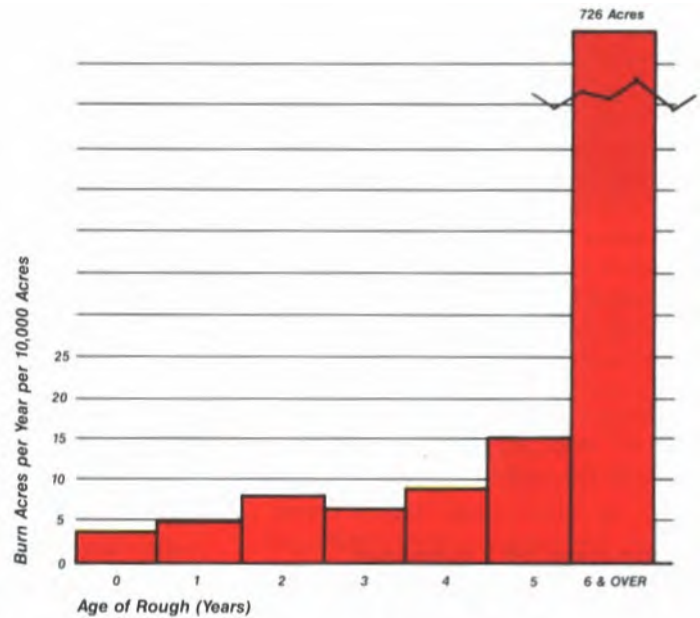

Annual wildfire acreage depends on age of rough

Reduce Hazardous Fuels

Forest fuels accumulate rapidly in pine stands on the Coastal Plain. In 5 to 6 years, heavy "roughs" can build up, posing a serious threat from wildfire to all forest resources.

Prescribed fire is the most practical way to reduce dangerous accumulations of combustible fuels under southern pine stands. Wildfires that burn into areas where fuels have been reduced by prescribed burning cause less damage and are much easier to

control. The appropriate interval between prescribed burns for fuel reduction varies with several factors, including the rate of fuel accumulation, past wildfire occurrence, values at risk, and the risk of a fire. The time interval between fires can be as often as every year although a 3- or 4-year cycle is usually adequate after the initial fuel-reduction burn.

The need to reduce hazardous fuel accumulations in the pine plantations of the South is increasing. Without fuel reduction, fire hazard is extremely

high in these vast contiguous stands. The initial hazard-reduction burn in a young pine stand requires exacting conditions of wind, humidity, and temperature. Higher wind velocities and cooler temperatures minimize scorch damage. Southern pine plantations averaging 10 to 12 feet in height can be burned by experienced people under the right conditions without damage. Young plantations on industrial lands are often burned for the first time when they are 15 to 20 feet tall using aerial ignition; close spacing



Winter backing fire in heavy rough



Damaging wildfire in heavy rough

of ignition spots (e.g., 2 chains by 2 chains), and cool, damp conditions with some wind are a must to avoid crown damage.

Subsequent fuel reduction burns need not cover the entire area. The objective is to break up fuel continuity. Fuel reduction on 75 to 80 percent of the area is sufficient. An added advantage of "patchy" burns is that the unburned islands provide cover for wildlife. These unburned patches will not have a dangerous accumulation of fuels at the time of the next burn if they resulted from a lack of fuel during the previous fire. If, however, they were too wet to burn, these islands could result in a hot spot the next time if a heading fire was allowed to sweep through them under appreciably drier conditions. One reason excessive crown scorch should be avoided is because, under some circumstances, it can add more fuel to the forest floor than the fire consumed.

Dispose of Logging Debris

After harvest, unmerchantable limbs and stems are left either scattered across the area or concentrated at logging decks or delimiting gates, depending upon the method of logging. This material is an impediment to both people and planting equipment. If a wildfire occurs within the next few years, fireline construction can be severely hindered; the result being larger burn acreages and higher regeneration losses. Although not all large material will be consumed by a prescribed fire, what is left will be exposed so it can be avoided by tractor-plow operators. In stands that produce a large amount of cull material, the debris is often windrowed and burned. This practice should, however, be avoided whenever practical because of smoke management problems and the potential for site degradation. Broadcast burning is generally a much better alternative. If the debris must be piled before burning, construct round "haystack" piles when the debris and underlying ground are both fairly dry. This step will limit the amount of dirt in the pile. Piles containing large amounts of dirt can seldom be burned efficiently. They almost always smolder for long periods, creating unacceptable smoke problems.



Prescribed fire can improve wildlife habitat

In some cases overstory pines are left during harvest as seed trees, and in others an unevenaged management system such as shelterwood is used. In both situations, the logging debris can still be burned, but you must take more care to protect the remaining trees.

Prepare Sites for Seeding or Planting

Prescribed burning is useful when regenerating southern pine by direct seeding, planting, or natural regeneration. On open sites, fire alone can expose adequate mineral soil and control competing vegetation until seedlings become established. Where competing vegetation cannot be adequately reduced by fire, follow up with mechanical or chemical treatment. The fire will improve visibility so that equipment operators can more easily see the stumps of the harvested trees, as well as any other hazards. In addition, if the area is to be bedded before planting, burning first consumes much of the debris. The result is more tightly packed beds and thus better seedling survival. Where herbicides are used to kill competition, subsequent burning will give additional vegetation control. This step also permits more efficient and easier movement of hand-planting crews. Prescribed fire also recycles nutrients, making them available for the next timber crop.

For natural regeneration, knowledge of anticipated seed crop and date of earliest seed fall is essential. If the

seed crop is inadequate, burning can be postponed. Complete mineral soil exposure is not necessary or desirable; a thin layer of litter should remain to protect the soil. Generally, burning should be done several weeks prior to seed fall. Timing varies with species and locality.

Improve Wildlife Habitat

Prescribed burning is highly recommended for wildlife habitat management where loblolly, shortleaf, longleaf, or slash pine is the primary overstory species. Periodic fire tends to favor understory species that require a more open habitat. A mosaic of burned and unburned areas tends to maximize "edge effect" which promotes a large and varied wildlife population. Deer, dove, quail, and turkey are game species that benefit from prescribed fire. Habitat preferences of several endangered species, including the Florida panther, gopher tortoise, indigo snake, and red-cockaded woodpecker are also enhanced by burning. Wildlife benefits from burning are substantial. For example, fruit and seed production is stimulated. Yield and quality increases occur in herbage, legumes, and browse from hardwood sprouts. Openings are created for feeding, travel, and dusting.

Selecting the proper size, frequency, and timing of burns is crucial to the successful use of fire to improve wildlife habitat. Prescriptions should



Summer burn for hardwood control



Hardwood topkill after summer burn

recognize the biological requirements (such as nesting times) of the preferred wildlife species. Also consider the vegetative condition of the stand and, most importantly, the changes fire will produce in understory stature and species composition.

Manage Competing Vegetation

Low-value, poor-quality, shade-tolerant hardwoods often occupy or encroach upon land best suited to growing pine. Unwanted species may crowd out or suppress pine seedlings. In soils with a high clay content and in areas with low rainfall during parts of the growing season, competition for water, nutrients and growing space may significantly lower growth rates of the overstory. Furthermore, understory trees and shrubs draped with dead needles and leaves act as ladder fuels allowing a fire to climb into the overstory crowns. In most situations, total eradication of the understory is neither practical nor desirable.

However, with the judicious use of prescribed fire, the understory can be managed to limit competition with desired species while at the same time providing browse for wildlife.

Burning is most effective in controlling hardwoods less than 3 inches in diameter at the ground line. Periodic fires throughout the rotation can keep competing vegetation below this 3-inch threshold. The most desirable season for burning and the frequency of burns will vary somewhat by species and physiographic region. Generally, a winter (dormant season) fire results in less root kill than a late spring or summer burn. One system recommended in both the Piedmont and Coastal Plain is a dormant season burn to reduce initial fuel mass, followed by two or more annual (if enough fuel is present) or biennial summer burns.

If not controlled, the hardwoods will form a midstory and capture the site once the pine is harvested. If a large pine component is wanted in the next rotation, these unmerchantable hardwoods must be removed during site preparation — an expensive

proposition. Generally, fire is required in combination with other treatments involving heavy equipment, chemicals, or both. In many locations the preferred system is a combination summer burn and herbicide treatment.

However, in the lower Appalachians of South Carolina, another relatively inexpensive technique is employed. All residual hardwoods are felled and the area broadcast burned under exacting fuel and weather conditions.

Control Insects And Disease

Brownspot disease is a fungal infection that may seriously weaken and eventually kill longleaf pine seedlings. Diseased seedlings tend to remain in the grass stage. Control is recommended when more than 20 percent of the seedlings are infected or when some of the diseased seedlings are needed for satisfactory stocking. Once the seedlings become infected, burning is the most practical method of disease control. Any type of burning that kills



Longleaf pine infected with brownspot needle blight



...and after prescribed fire

the diseased needles without killing the terminal bud is satisfactory. Burning the infected needles reduces the number of spores available to infect the seedlings. Generally a fast-moving winter heading fire under damp conditions, as exist after passage of a strong cold front, is best. Height growth of the seedlings often begins the first postfire growing season.

Reinfection usually occurs quickly if there are infected seedlings in unburned areas near the burned area. If reinfection occurs, additional burns may be needed. However, longleaf is most susceptible to fire immediately after it comes out of the grass stage. Therefore, a reburn will likely kill some seedlings, so such a decision should be made in consultation with

experienced personnel. Your local State forestry office is a good place to begin.

Prescribed burning seems to reduce problems from *Fomes annosus* root rot. This fungal disease is less frequent where periodic burns have reduced the litter. The fire alters the microenvironment of the forest floor and perhaps destroys some fruiting bodies and cauterizes tree stumps.

Prescribed fire has been successfully used under very exacting fuel and weather conditions to control cone insects such as the white pine cone beetle (*Conophthorus coniperda*) while the pest is overwintering in cones on the ground. Prescribed burning costs much less than traditional chemical control methods used to control this beetle.

Improve Forage for Grazing

Prescribed burning improves grazing in open pine stands on the Coastal Plain. Low-intensity burns increase availability, palatability, quality, and quantity of grasses and forbs. Dead material low in nutrient value is removed while new growth high in protein, phosphorus, and calcium becomes readily available. These benefits are manifested in increased seasonal cattle weight gains. Cattle congregate on recently burned areas so burn location and size must be carefully selected to prevent overgrazing. One commonly used system is to divide the range into three parts and burn one third every year.

A plant may become more — or less — abundant after a fire. The result depends on the stage in the plant's life cycle at the time of the fire. Flowering dates vary among species and with latitude and elevation within a species' range. Therefore, observe these dates for the preferred species, and time the burn accordingly. For example, wiregrass responds much better to summer burns than it does to dormant season burns.



Prescribed fire improves range habitat

Enhance Appearance

Prescription burning improves recreation and aesthetic values. For example, burning maintains open stands, produces vegetative changes, and increases numbers and visibility of flowering annuals and biennials. Burning also maintains open spaces such as mountain balds, and creates vistas. Unburned islands increase vegetative diversity which attracts a wider variety of birds and animals. A practical way to maintain many visually attractive vegetative communities and perpetuate many endangered plant species is through the periodic use of prescribed fire.

Using fire to manage landscapes and enhance scenic values requires judiciously planned and executed burns, especially where exposure to the public is great. Burning techniques can be modified along roads and in other heavily used areas to ensure low flame heights, which in turn will reduce crown scorch and bark char while still opening up the stand and giving an unrestricted view.



Warm-season grasses promoted by summer burning

Improve Access

Burning underbrush prior to the sale of forest products improves the efficiency of cruising, timber marking, and harvesting. Removing accumulated material before harvesting also provides greater safety for timber markers, loggers and naval stores operators due to better visibility and less underbrush. The reduced amount of fuel helps offset the greater risk of wildfire during harvesting. Moreover, the improved visibility and accessibility often increase the stumpage value of the products. Hikers and other users also benefit from easier travel and increased visibility. Hunters are more likely to get a clear shot.



Limited access due to fire exclusion

Perpetuate Fire-dependent Species

Many plants have structural adaptations, specialized tissues, or reproductive features that favor them in a fire-dominated environment. Such traits suggest a close association with fire over a very long period of time. Many endemics are only found the first 1 to 2 years after a fire. Changes in the "natural" fire pattern as a result of attempted fire exclusion have led to dramatic decreases in many of these fire-tolerant or fire-dependent species. Many picturesque flowers, including several orchids, currently listed as threatened or endangered are benefited by fire.

Prescribed burning, however, does not automatically help perpetuate plant and animal species because fires are not necessarily conducted during the same season in which the site historically burned. The interval between prescribed fires as well as fire intensity may also differ from those of the past. The individual requirements of a species must therefore be understood before a fire can be prescribed to benefit that species.



*Open stand resulting from **annual** winter burning*



Pitcher plants respond to prescribed fire

*Prescribed Burning=
Good Wildlife Habitat*

As a stand matures, an increasing proportion of the nutrients on the site become locked up in the vegetation and are unavailable for further use until plants die and decompose. Low-intensity fires speed up this recycling process, returning nutrients back to the soil where they are again available to plants. Under many conditions, burning may increase nitrogen fixation in the soil and thus compensate for nitrogen loss to the atmosphere that results from burning the litter layer. When duff layers are not completely consumed, changes in soil pore space and infiltration rate are very slight. If mineral soil is repeatedly exposed, rain impact may clog fine pores with soil and carbon particles, decreasing infiltration rates and aeration of the soil.

A major concern of the forest manager is how fires affect surface runoff and soil erosion. On most Lower and Middle Coastal Plain sites, there is little danger of erosion. In the steeper topography of the Upper Coastal Plain and Piedmont, some soil movement is possible. However, if the burn is under a timber stand and some duff remains, soil movement will be minor on slopes up to 25 percent. The amount of soil movement will be greater after site preparation with heavy machinery than after prescribed burning.

Care must be taken when clearcut logging slash is burned on steep slopes. Until grass and other vegetation cover the site, surface runoff and soil erosion may occur. The burning

phase of the "fell and burn" site-preparation technique commonly used in the upper Piedmont and mountains should be completed by mid-September. This timing allows herbaceous plants to seed in and provide a winter ground cover. Burning should not be done if exposure of highly erosive soils is likely.

Soil should be wet or damp at the time of burning to ensure that an organic layer will remain after a prescribed burn. Moisture not only protects the duff layer adjacent to the soil, but also prevents the fire from consuming soil humus. If the forest floor is completely consumed, the microenvironment of the upper soil layer will be drastically changed, making conditions for near-surface tree roots very inhospitable. Damp soil also aids mop-up after the burn.

Effects on Water

The main effect of prescribed burning on the water resource is the potential for increased runoff of rainfall. When surface runoff increases after burning, it may carry suspended soil particles, dissolved inorganic nutrients, and other materials into adjacent streams and lakes reducing water quality. These effects seldom occur after Coastal Plain burns. Problems can be avoided in hilly areas or near metropolitan water supplies by using properly planned and conducted burns.

Rainwater leaches minerals out of the ash and into the soil. In sandy

soils, leaching may also move minerals through the soil layer into the ground water. Generally, a properly planned prescribed burn will not adversely affect either the quality or quantity of ground or surface water in the South.

Effects on Air

Prescribed fires may contribute to changes in air quality. Air quality on a regional scale is affected only when many acres are burned on the same day. Local problems are more frequent and occasionally acute due to the large quantities of smoke that can be produced in a given area during a short period of time.

Smoke consists of small particles (particulate) of ash, partly consumed fuel, and liquid droplets. Other combustion products include invisible gases such as carbon monoxide, carbon dioxide, hydrocarbons, and small quantities of nitrogen oxides. Oxides of nitrogen are usually produced at temperatures only reached in piled or windrowed slash or in very intense wildfires. In general, prescribed fires produce inconsequential amounts of these gases. Except for organic soils (which are not generally consumed in prescribed burns), forest fuels contain very little sulfur, so oxides of sulfur are not a problem either.

Particulates, however, are of special concern to the prescribed burner because they reduce visibility. The amount of particulate put into the air depends on amount and type of fuel consumed, fuel moisture content, and rate of fire spread as deter-



Protect streamside zones

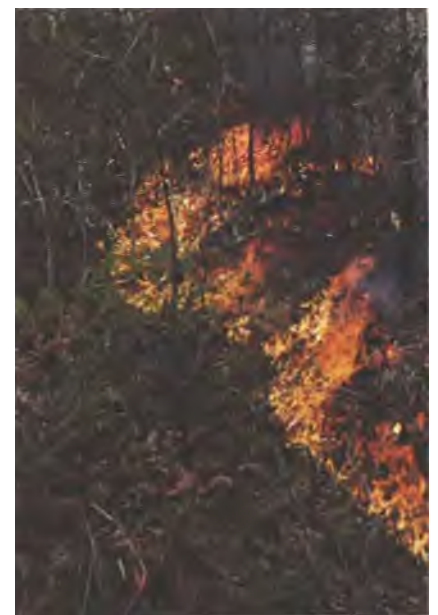

Backing fires produce less smoke than heading fires

mined by timing and type of firing technique used. Rate of smoke dispersal depends mainly on atmospheric stability and windspeed.

Effects of smoke can be managed by burning on days when smoke will blow away from smoke-sensitive areas. Precautions must be taken when burning near populated areas, highways, airports, and other smoke-sensitive areas. Weather and smoke management forecasts are available as a guide for windspeed and direction. Any smoke impact downwind *must* be considered before lighting the fire. The burner may be liable if accidents occur as a result of the smoke. All burning should be done *in* accordance with applicable smoke management guidelines and regulations. During a regional alert when high pollution potential exists, all prescribed burning should be postponed.

Nighttime burning should be done with additional care because a temperature inversion may trap the smoke near the ground. This smoke can create a serious visibility hazard, especially in the presence of high humidities (which occur on most nights). In particular, smoke mixing with existing fog will drastically reduce visibility. Cool air drainage at night will carry smoke downslope, causing visibility problems in lowlands and valleys. On the Coastal Plain, nighttime air drainage often follows waterways. Conditions can be especially hazardous near bridge crossings because of the higher humidity there. Of course, the earlier

in the day a fire is completed, the less likely it is to cause nighttime smoke problems. More complete mopup following daytime burning and nighttime burning only under very stringent prescriptions can minimize the occurrence of these problems. Your local State forestry office can help with planning nighttime burns.

Effects on Human Health and Welfare

Occasional brief exposure of the general public to low concentrations of drift smoke is more a temporary inconvenience than a health problem. High smoke concentrations can, however, be a very serious matter, particularly near homes of people with respiratory illnesses or near health-care facilities.

Smoke can have negative short- and long-term health effects. Fire management personnel who are exposed to high smoke concentrations often suffer eye and respiratory system irritation. Under some circumstances, continued exposure to high concentrations of carbon monoxide at the combustion zone can result in impaired alertness and judgement. The probability of this happening on a prescribed fire is, however, virtually nonexistent.

Over 90 percent of the particulate emissions from prescribed fire are small enough to enter the human respiratory system. These particulates can contain hundreds of chemical compounds, some of which are toxic.

The repeated, lengthy exposure to relatively low smoke concentrations over many years can contribute to respiratory problems and cancer. But, the risk of developing cancer from exposure to prescribed fire has been estimated to be less than 1 in a million.

Although the use of herbicides in forest management has increased all chemicals are now tested before being approved for use, and we are more careful than ever to minimize their potential danger. Many of them break down rapidly after being applied. Moreover, both theoretical calculations and field studies suggest that prescribed fires are hot enough to destroy any chemical residues. Minute quantities that may end up in smoke are well within currently-accepted air quality standards. Threshold limit values (TLV's) are often used to measure the safety of herbicide residues in smoke. Expected exposure rates of workers to various brown-and-burn combinations have been compared with TLV's. They showed virtually no potential for harm to workers or the general public.

There is at least one group of compounds carried in smoke that can have an immediate acute impact on individuals. When noxious plants such as poison ivy burn, the smoke can cause skin rashes. These rashes can be much more widespread on the body than those caused by direct contact with the plants. If you breathe this smoke, your respiratory system can also be affected.

Effects on Wildlife

The major effects on wildlife are indirect and pertain to changes in food and cover. Prescribed fires can increase the edge effect and amount of browse material, thereby improving conditions for deer and other wildlife. Quail and turkey favor food species and semi-open or open conditions that can be created and maintained by burning. Burning can improve habitat for marshland birds and animals by increasing food production and availability.

The deleterious effects of prescribed fire on wildlife can include destruction of nesting sites and possible killing of birds, reptiles, or mammals trapped in the fire. Fortunately, prescribed fires can be planned for times when



Smoke sensitive areas can be impacted by prescribed fire

nests are not being used. Also, virtually all the types of prescribed fire used in the South provide ample escape routes for wildlife. For example, a large tract was operationally burned with aerially-ignited spot fires and immediately examined for wildlife mortality. Fish and game agency personnel found none, but noted deer moving back into the still-smoking burn. The ill-advised practice of lighting all sides of a burn area (ring firing) is a primary cause of animal entrapment and has no place in underburning. It also results in unnecessary tree damage as the flame fronts merge in the interior of the area.

Management of the endangered red-cockaded woodpecker presents a special problem because of the copious amounts of dried resin that stretch from the nest cavity toward the ground. The bird requires habitat historically maintained by fire, even though these pitch flows can be ignited, carrying fire up to the cavity. This is unlikely, however, if short flame lengths are prescribed. Fuel can also be raked from around cavity trees as an added precaution.

Prescribed fire does not benefit fish habitat, but it can have adverse effects. Riparian zone (streamside) vegetation must be excluded from prescribed burns to protect high quality plant and animal habitat, and water quality. When shade is removed, water temperatures will increase. Burning conditions are often unfavorable along streams because of increasing fuel moisture, making line plowing optional. But a buffer zone should always be left. If in doubt, a control line should be put in.

Effects on Aesthetics

The principal effect of prescribed burning on aesthetics can be summarized in one word: *contrast*. Contrast, or change from the preburn landscape, may be positive or negative depending largely on personal opinion. What may be judged an improvement in scenic beauty by one may be considered undesirable by another.

Many of the undesirable impacts are relatively short term and can be minimized by considering scenic qualities when planning a burn. For example, the increased turbulence and updrafts along roads and other forest openings will cause more intense fire with resulting higher tree trunk char and needle scorch.



Prescribed burning attracts wildlife

Generally, the more immediate unfavorable impacts such as smoke and ash, topkilled understory plants, and a blackened forest floor are necessary to achieve two major benefits — increased visual variety and increased visual penetration.

Variety or diversity in vegetative cover will create a more pleasing, general visual character to the stand. Similarly, scenic qualities of the forest can be better appreciated if the stand can be made more transparent. An example is the reduction of an understory buildup along a forest road that will permit the traveler to see into the interior of the stand, perhaps to a landscape feature such as a pond or

interesting rock outcrop. The smutty appearance of the ground will "green up" fairly quickly. Any scorched needles will soon drop and not be noticeable. Flowers and wildlife will increase.

Some important points are: 1) The apparent size of a burn can be reduced by leaving unburned islands to create a mosaic pattern of burned and unburned area. 2) Where hardwood inclusions are retained, make sure they are large enough to be relevant to the observer. 3) Observer criteria must be understood if reactions to a burn are to be predicted. Personal reactions will depend on observer distance, duration or viewing time, and aspect.



Aesthetics can be enhanced by prescribed fire

Weather and Fuel Considerations

Important Weather Elements

A general understanding of the separate and combined effects of several weather elements on the behavior of fire is needed if you are to plan and execute a good burn. Wind, relative humidity, temperature, rainfall, and airmass stability are the more important elements to consider. These factors influence fuel moisture which is critical to success. Because weather and fuel factors interact, an experienced prescribed burner can conduct a successful burn even with one or more factors slightly outside the desired range as long as they are offset by other factors. You should become familiar with local weather patterns that are favorable for prescribed burning as well as local "watchout" situations.

Good winter prescribed burning conditions often exist for several days after the passage of a cold front that has brought 1/4 to 3/4 inch of rain. During this time, persistent winds, low relative humidities, cool temperatures and sunny days can be anticipated. Weather conditions for summer burning are much less predictable.

Before starting to burn, obtain the latest weather forecast for the day of the burn and the following night. When possible, get a 2-day weather outlook. **Knowledge of weather is the key to successful prescribed burning, and is mandatory for proper management of smoke produced by burning.**



Anemometer



Precipitation gauge



Fire-weather shelter



Knowledge of weather is essential for a successful burn



Successful backing fires need steady winds

Sources of Weather Information

Ordinarily, four sources of weather information are available. Use one or more of them before and during prescription fires. The sources are:

- NATIONAL WEATHER SERVICE
- STATE FORESTRY AGENCIES
- LOCAL OBSERVATIONS
- PRIVATE WEATHER FORECASTING SERVICES

Local National Weather Service offices will furnish weather forecasts and outlooks via radio and television. Spot weather forecasts are also available, but their value depends upon the forecaster's knowledge of local conditions. Inexpensive radios are also available that continually monitor National Oceanic and Atmospheric Administration (NOAA) weather-related information and forecast updates. Do not rely solely on the NOAA broadcasts because this information is not specific enough for smoke-management planning.

The best source of information including current forecasts and outlooks is generally the local office of your State forestry agency. The person you talk to can often help you interpret the forecast, give you any warnings, and pass on pertinent information such as other burns planned for that day. The prescribed burner should take full advantage of such services.

All southern State forestry agencies and national forests, as well as many military bases and private concerns operate fire-danger stations. The basic weather parameters measured at these sites are very useful. However, National Fire

Danger Rating System (NFDRS) indices which are calculated from these measurements should not be used. This system was designed to provide a worst-case scenario for wildfire control over very large areas. It was not designed as a planning tool for prescribed burning!

Weather observations should be made at the prescribed burn site immediately before, during and immediately after a fire. Such observations are important because they serve as a check on the applicability of the forecast and keep the burning crew up-to-date on any local influences or changes. Take readings in a similar area upwind of the fire to avoid heating and drying effects of the fire. Do this at 1- to 2- hour intervals, or more often if changes in fire behavior are noticed. Measurements taken in an open area, on a forest road, and in a stand are likely to differ widely. Easy-to-use belt weather kits that include a psychrometer and an anemometer are available. By using this kit and observing cloud conditions, a competent observer can obtain a fairly complete picture of the current weather.

Wind

Underburning

Prescribed fires behave in a more predictable manner when windspeed and direction are steady. Onsite winds vary with stand density and crown height. Windspeed generally increases to a maximum in the early afternoon and then decreases to a minimum after sunset. The preferred range in windspeed **in the stand** is 1 to 3 mph (measured at eye-level) for most fuel and topographic situations.

Windspeed readings for most fire-weather forecasts are, however, taken 20 feet above ground at *open* locations. Windspeeds in fire-weather forecasts are the maximum expected and not the average for the day. The minimum 20-foot windspeed for burning is about 6 mph and the maximum is about 20 mph. These are the most desirable winds for prescribed burning, but specific conditions may tolerate other speeds. As a general rule higher windspeeds are steadier in direction.

Relatively high winds quickly dissipate the heat of a backing fire. The result is less crown scorch than from a fire backing into a low-speed wind. In-stand windspeeds should be in the low to middle range (1 to 2 mph) when heading fires are used. With high winds, heading fires spread too rapidly and become too intense. On the other hand, enough wind must be present to keep the heat from rising directly into tree crowns. Mature southern pine stands with a sparse understory can be burned at very low windspeeds — just enough to give direction to the fire.

Of greater importance than windspeed is the *length of time* the wind blows from one direction. Persistent wind directions occur frequently during winter, especially following passage of a cold front when winds are typically from the west or northwest. As these winds slowly shift clockwise over the next few days, they become weaker and less steady. Winds with an easterly component are generally considered undesirable for prescribed burning. However, along the coast, sea and land breezes are often utilized. Ir-

respective of direction, a forecast of wind steadiness should always be obtained. For sites near the coast, also obtain the expected time of sea breeze arrival and departure.

The most critical areas, with regard to fuel and topography, should be burned when wind direction is steady and persistent. Relatively easy burns can be conducted under less desirable wind conditions. Topography, and local effects such as stand openings, roads, etc. may have a bearing on favorable wind conditions and should always be considered when planning a burn.

**PREFERRED IN-STAND WIND:
1 MPH to 3 MPH**

Debris Burning

Winds are stronger in open areas than they are in the forest. Because there is no overstory to protect, wind is not needed to cool the heated combustion products. However, from a smoke management standpoint, the stronger the wind the better the dispersion—provided there are no downwind smoke-sensitive areas that will be impacted. When broadcast burning, eye-level winds over 3 to 4 mph can create containment problems if a heading fire is used. With piled or windrowed debris, eye-level winds of 8-10 mph can be tolerated by adjusting the firing pattern.

Wind direction may change substantially with height, but it is these transport winds that regulate

the movement of the smoke column. Moderate transport windspeeds allow a convection column to develop that exhausts the smoke high into the atmosphere where it quickly disperses with a minimum impact on ground-level air quality. Before setting a fire that will generate a convection column, however, obtain information on the existing and forecast wind profiles. If an adverse profile exists, it is likely to result in an unacceptably high spotting potential. Fire behavior characteristics are associated with various wind profiles. They are described in Byram's publication, listed in the Suggested Reading section. Once the fire has died down and smoke production is from smoldering combustion, surface wind is necessary to ensure good smoke dispersion.

Relative Humidity

Underburning

Relative humidity is an expression of the amount of moisture in the air compared to the total amount the air is capable of holding at that temperature and pressure. Each 20° rise in temperature (which often occurs during the morning hours on a clear day) reduces the relative humidity by about half, and likewise, each 20° drop in temperature (which often occurs in early evening) causes relative humidity to roughly double. When a cold front passes over an area, the air behind the front is cooler and drier than the old airmass it is replacing. The result is a drop in both

temperature and humidity.

Preferred relative humidity for prescribed burning varies from 30 to 55 percent. Under special conditions, a wider range of relative humidities, as low as 20 percent and as high as 60 percent, can produce successful burns. When relative humidity falls below 30 percent, prescribed burning becomes dangerous. Fires are more intense under these conditions and spotting is much more likely; proceed only with additional precautions. When the relative humidity is 60 percent or higher, a fire may leave unburned islands or may not burn hot enough to accomplish the desired result.

The moisture content of fine, dead fuel such as pine needles and dried grasses responds rapidly to changes in relative humidity. However, there is a timelag involved for fuels to achieve equilibrium with the moisture condition of the surrounding atmosphere. Also, previous drying and wetting will influence fuel moisture. Therefore, the relative humidity and fuel moisture must be assessed independently.

**PREFERRED HUMIDITY :
30 TO 55 PERCENT**

Debris Burning

Relative humidity (along with temperature) controls fuel moisture content up to about 32 percent. Liquid moisture such as rain or dew



The belt weather kit and additional wind meter

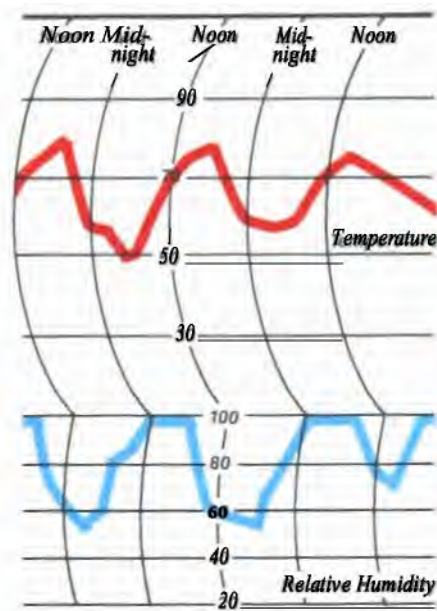

**Daily temperature/
relative humidity cycle**

must contact a fuel for moisture content to rise above 32 percent, and the increase depends upon duration as well as the amount of precipitation.

Recently-cut pine tops have a drying rate that is somewhat independent of relative humidity as long as the moisture content of fresh tops (needles still green) is above about 32 percent. Once this material initially dries to a moisture content below 32 percent, it behaves as a dead fuel and becomes much more responsive to daily fluctuations in relative humidity. The response to changes in relative humidity is much more rapid in fine dead fuels suspended above the ground than in those that have become part of the litter layer. These elevated needles and other suspended dead materials are not in contact with the damp lower litter and are more exposed to the sun and wind.

When burning piled debris, once the larger-diameter fuels ignite, increases in relative humidity have little effect on fire behavior during the active burning phase. Low humidities (below 30 percent), however, will promote spotting and increase the likelihood of fire spreading between piles.

Temperature

Underburning

The average instantaneous lethal temperature for living tissue is about 145°F. Air temperatures below 60°F are recommended for winter underburns because more heat is needed to raise foliage or stem tissue to lethal temperature levels. When the objective is to control undesirable species, growing-season burns with ambient air temperatures above 80°F are recommended. These conditions increase the likelihood of reaching killing temperatures in understory stems and crowns. Of course, the overstory pines must be large enough to escape injury. Larger trees have thicker bark and their foliage is higher above the flames, which allows more room for the hot gases to cool before reaching the crowns.

Temperature strongly affects moisture changes in forest fuels. High temperatures help dry fuels quickly. When fuels are exposed to direct solar radiation, they become much warmer than the surrounding air. Moisture will move from the warmer fuel to the air even though the relative humidity of the air is

high. Temperatures below freezing, on the other hand retard fire intensity because additional heat is required to convert ice to liquid water before it can be vaporized and driven off as steam. Consequently, it does not take much moisture under these conditions to produce a slow-moving fire that will leave unacceptably large areas unburned.

*PREFERRED WINTER
TEMPERATURE:
BELOW 60°F*

Debris Burning

Cleared areas are often burned when ambient air temperatures are high. There is no overstory present to worry about and surface heating from direct sunlight usually increases the mixing height which helps disperse the smoke.

It is particularly important to use an ignition pattern such as center tiring when ambient air temperatures are high. This tactic draws the heat into the cleared area and prevents heat damage to trees in adjacent stands.

Rainfall and Soil Moisture

Underburning

Because rainfall affects both fuel moisture and soil moisture, you should have some idea of the amount of rain falling on the area to be burned. In winter, rainfall is fairly easy to forecast throughout the South. In summer, when shower activity prevails, predicting rainfall at individual locations is much more difficult. The only reliable method to determine the amount of precipitation that actually falls is to place an inexpensive rain gauge on the site.

The importance of adequate soil moisture can't be overemphasized. Damp soil protects tree roots and microorganisms. Even when burning to expose a mineral soil seedbed it is desirable to leave a thin layer of organic material to protect the soil surface. Burning should cease during periods of prolonged drought and resume only after a soaking rain of *at least 1 inch*. As soil moisture conditions improve, less rain is needed before burning. If recent precipitation has been near average, 1/4 to 1/2 inch of rain followed by sunny skies, brisk

winds, and low humidities will generally result in several days of good prescribed fire conditions with adequate soil protection.

On clay soils, such as are found in the Piedmont, much of the rainfall is lost through surface runoff, and duration is more important than amount. For example, 1 inch of rain occurring in 1/2 hour will not produce as large a moisture gain as 1/2 inch falling over a 2 hour period.

*PREFERRED SOIL
MOISTURE: DAMP*

Debris Burning

Generally, rain has a much greater effect on fuel moisture in cleared areas than under a stand because none is intercepted by tree canopies. However, fuels also dry much faster in cleared areas because of increased sunlight and higher windspeeds. This differential drying can often be used to advantage from a fire-control standpoint. Burn the cleared area several days after a hard rain while fuels in the surrounding forest are still damp. Burning under these conditions assures good soil moisture. However, when burning cleared areas, soil damage is as much a function of fire intensity and duration as it is of soil moisture. Intense, long-duration fires will bake the soil regardless of the moisture present. Both the chemical and physical properties of the soil can be altered. This type of fire should be avoided, especially on clay soils and steep slopes. These undesirable fire effects are often produced when burning windrowed or piled debris, and are one reason piling or windrowing slash prior to burning are discouraged.

Fine-fuel Moisture

Underburning

Fine-fuel moisture is strongly influenced by rainfall, relative humidity, and temperature. The preferred range in *actual (not calculated)* fine-fuel moisture of the upper litter layer (the surface layer of freshly fallen needles and leaves) is from 10 to 20 percent. Burning when fine-fuel moisture is below 6 or 7 percent can result in damage to plant roots and even the soil. When fine-fuel moisture ap-



Fuel-moisture sticks

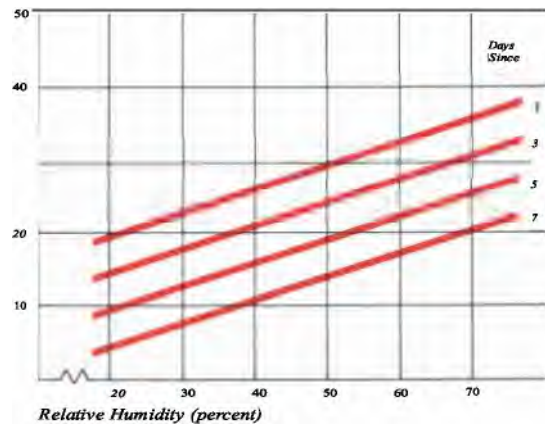

Effects of humidity and days since rain on fine-fuel moisture

proaches 30 percent, fires tend to burn slowly and irregularly, often resulting in incomplete burns that do not meet the desired objectives. However, when areas with very heavy fuel buildups or extensive draped fuels are burned, moisture content should be 20 to 25 percent to keep fire intensity manageable, especially if aerial ignition techniques are used. Fine-fuel moisture values obtained from NFDRS tables on fire-behavior models are considerably less than these actual values.

Some experienced practitioners can accurately estimate fuel moisture by examining a handful of litter. However, the only sure way to tell is to take a sample and oven-dry it. Tables and equations in the National Fire Danger Rating System and BEHAVE can be used to estimate fine-fuel moisture, but the results are invariably underestimates (because they are worst-case values designed for use in predicting wildfire behavior). One simple test that will give a *very rough* estimate of the upper-litter-layer moisture content is to pick up a few pine needles and individually bend each in a loop. If the needles snap when the width of the closing loop is about 1/4 to 1/2 inch, their moisture content is between 15 and 20 percent. If they do not snap in two, they are too wet to burn well. If they crumble into small pieces they are exceedingly dry and even if the lower litter is moist, the fire may cause damage and be difficult to control. Fuel moisture sticks that respond to weather changes like 10-hour fuels are available. With a *good* set of scales and proper placement of the sticks, acceptable fuel moisture

estimates can be obtained just before ignition. These values will differ slightly from actual fine-fuel moistures, but are fairly representative of most southern fuel types. They are much closer to actual fine-fuel moistures than are calculated or tabular values.

Lower litter should always be checked before burning to make sure it feels damp. This will help ensure that some remains, even though charred, to leave a protective covering over the soil. Generally, the moisture content increases from the litter surface down through the duff layer to the soil. Exceptions can occur after a light shower, or in the morning after a heavy dew. In these cases, fires often burn more intensely than would be expected from just looking at the upper-litter-layer moisture content. When burning on organic soils this phenomenon can have drastic consequences. If the fire dries the moist surface layer of peat, the organic soil will ignite. These fires can impact an area for many weeks in spite of control efforts, causing extensive smoke problems.

The speed with which fine fuels respond to changes in humidity depends on fuelbed characteristics such as whether the fuelbed consists of compacted hardwood leaves or jack-strawed pine needles. Different fuel types can reach different moisture contents under the same humidity conditions. For example, grassy openings containing cured material can be burned within hours of a drenching rain if good drying conditions exist. Because of these natural variations, recommended fine-fuel moisture values are only guidelines.

On-the-ground knowledge of fuels must be incorporated into the prescription.

Fuel moisture also influences smoke production. When very damp woody fuels burn, large amounts of characteristic white smoke are given off. Much of the visible smoke plume is actually condensed water vapor.

**PREFERRED FINE-FUEL
MOISTURE:
10 TO 20 PERCENT**

Debris Burning

Harvested areas should be burned when fuels are dry. They will ignite easier, burn more quickly and completely, shortening the time necessary to complete the burn. Less mopup will be required and the impact on air quality will be reduced. The short but severe summer droughts common throughout much of the South provide ideal burning conditions on cleared areas, provided soil moisture does not get too low.

To avoid the possibility of unnecessary damage to the site, debris should be burned as it lies (broadcast burned) rather than piled. Because fuels on logged areas receive full solar radiation, they dry before surrounding forest fuels do. It takes at least several weeks after cutting for the severed tree tops to cure. Once the needles turn a greenish-yellow

*Prescribed Burned Forests
are More Productive*

and the hardwood leaves wither, the debris is ready to burn. Cleared areas can then be safely burned soon after a rain, before adjacent forest fuels dry enough to burn well. Ten-hour fuel moisture (fuels 1/4 to 1 inch in diameter, such as branches and small stems) is a better indicator of burning conditions in slash fuels than is fine-fuel moisture. Fuel moisture sticks will give excellent results. One set of "sticks" can be placed on the area to be burned and another in the nearby undisturbed forest. Let the sticks become acclimated for at least 2 weeks before reading. Many managers consider the area ready to burn when the moisture content of the sticks on the logged area reaches about 10 percent while that of those in the forest is still above 15 percent.

If the burn objective is to consume larger fuels (over 2 to 3 inches in diameter), piling will probably be necessary. Piling in wet weather should be avoided. Keep the piles small and free of dirt. Allow fresh logging debris to cure for several weeks before piling because drying conditions are exceedingly poor in the middle of a pile, especially if it is compacted or contains much dirt. Much of the smoke problem associated with burning piled debris is caused by inefficient combustion of damp, soil-laden piles. These piles may smolder for days or weeks.

Airmass Stability and Atmospheric Dispersion

Underburning

Atmospheric stability is the resistance of the atmosphere to vertical motion. When the atmosphere is stable, temperature decreases slowly as altitude increases (less than 5.5°F per 1,000 feet). Under very stable conditions, inversions may develop in which temperature actually increases with height. The distance from the ground to the base of this inversion layer is called the mixing height. Under less stable atmospheric conditions, other factors beyond the scope of this discussion determine the height of the mixing layer. In either case, the mixing layer is defined as the layer of air within which vigorous mixing of smoke and other pollutants takes place. The average windspeed throughout the mixing layer is called the transport windspeed. Mixing heights above 1,700 feet and transport

windspeeds above 9 mph are desirable for good smoke dispersion. Some prescribed burners on the Ozark Plateau believe their fires become difficult to control when the mixing height is greater than 6,500 feet.

The old adage that hot air rises is true but only as long as it is warmer than the surrounding air. Thus, stable air tends to restrict convection column development and produces more uniform burning conditions. However, combustion products are held in the lower layer of the atmosphere (especially under temperature inversions). Visibility is likely to be reduced because of smoke accumulation. As the earth cools each night, the air near the ground is cooled more than the air above, forming a stable layer. Because this cold air is denser, it drains into low-lying areas such as swamps and bottomlands, carrying with it smoke from smoldering stumps, branches and other debris.

When the atmosphere is unstable, the decrease in temperature with height exceeds 5.5°F per 1,000 feet. Once a parcel of air starts to rise, it will continue to rise until it cools to the temperature of the surrounding air. Such conditions promote convection and rapid smoke dispersion but, if severe, can make fire control difficult.

A neutral atmosphere is one in which a rising parcel of air remains at the same temperature as its surrounding environment (i.e., the temperature decrease with altitude equals the dry adiabatic lapse rate of 5.5°F per 1,000 feet). Smoke dispersion in a neutral atmosphere can be adequate if windspeed is sufficiently high. But remember, you need to account for the effect of the wind on fire control.

Obtain forecasts of mixing height, transport windspeed, and atmospheric stability, but also observe local indicators at the fire site. Indicators of a stable atmosphere are steady winds, clouds in layers, and poor visibility due to haze and smoke hanging near the ground. Unstable conditions are indicated by dust devils, gusty winds, clouds with vertical growth, and good visibility.

A prescribed fire generates vertical motion by heating the air. If the atmosphere is unstable, the hot combustion products will rise rapidly

because of the large temperature difference between the smoke and surrounding air. The column will continue to build in height as long as it remains relatively stationary and is heated by new combustion products faster than it is being cooled. The stronger the convective activity, the stronger the indrafts into the fire. This effect increases fire intensity by producing even stronger convective activity. Eventually spotting, crowning and other indicators of erratic fire behavior develop. Suppress a fire as quickly as possible to hold damage to a minimum. With adequate planning, this situation rarely develops when underburning, using conventional ground-ignition techniques. However, when using aerial ignition techniques at the high end of the prescription window, you can ignite too much area too quickly. This action results in severe damage to the overstory. The behavior of the first row or two of spots should warn the burning boss to halt ignition and observe fire behavior before making a decision to adjust the ignition pattern, change firing techniques, or terminate the burn.

**PREFERRED STABILITY:
SLIGHTLY UNSTABLE OR
NEUTRAL**

**PREFERRED MIXING HEIGHT:
1,700 TO 6,500 FEET ABOVE
GROUND**

**PREFERRED TRANSPORT
WINDSPEED:
9 TO 20 MPH**

Debris Burning

Strong convection over cleared areas burned for site preparation or slash disposal helps vent smoke into the upper atmosphere. A convection column will continue to rise until it cools to the temperature of the surrounding air or until it reaches the base of an inversion layer. A well-developed convection column produces strong indrafts which help confine this type fire to its prescribed area. Care must be taken to ensure that all

burning materials sucked into the convection column burnout before being blown downwind and dropping to the ground to act as firebrands.

Whenever a burn site is in hilly terrain, diurnal slope winds must be considered. As soon as a slope is heated by the morning sun, an upslope breeze results. This breeze will increase to a maximum (<8 mph) during the early afternoon and end as the slope cools in the evening. As the slope continues to cool, a downslope wind will develop, reaching a maximum (<5 mph) after midnight. This breeze will end after sunup as the slope again begins its daily heating cycle. If you ignite a tire at the base of a slope during the day, differential heating will be greatly increased. The fire will rapidly spread uphill, giving the combustion products added lift to help vent them into the atmosphere. However the nighttime downslope wind will have the opposite effect, concentrating any drift smoke in low areas.

*Weather is the Vital Element of
Prescribed Burning -- Use the
Weather Forecasts*



High fuel moistures produce lots of smoke



Stable conditions or a low mixing height keep smoke near the ground



Unstable conditions and/or a high mixing height provide for rapid smoke dispersion

Firing Techniques

General

Various firing techniques can be used to accomplish a burn objective. The technique chosen must be correlated closely with burning objectives, fuels, topography, and weather factors to prevent damage to forest resources. The proper technique to use can change as these factors change. Atmospheric conditions should be favorable for smoke to rise into the upper air and away from smoke-sensitive areas such as highways, airports, and urban areas.

Based on behavior and spread, fires either move with the wind (heading fire), against the wind (backing fire), or at right angles to the wind (flanking fire). The movement of any fire can be described by these terms. For example, a spot fire would exhibit all three types. Heading fire is the most intense because of its faster spread rate, wider flaming zone, and longer flames. Backing fire is the least intense, having a slow spread rate regardless of windspeed. This type of fire has a narrow flaming zone, and short flames. Flanking fire intensity is intermediate. The slope of the land has an effect on rate of spread similar to that of wind.

If you encounter slight variations in fuel volumes or weather conditions, consider combining two or more firing techniques to achieve the desired result. A solid line of fire always spreads faster and thus builds up intensity quicker than does a series of spot ignitions spaced along the same line. Intensity increases abruptly when two fires burn together. The magnitude of this increase is greater when fires converge along a line rather than along a moving point. The line of crown scorch often seen paralleling a downwind control line delineates the zone where a heading fire and a backing fire met.

Residence time is the time it takes the flaming zone to move past a given point. The residence time of heading and backing prescribed fires is often about the same because the deeper flame depth of a heading fire

compensates for its faster movement. Generally, backing fires consume more forest floor fuels than do heading fires. The total heat applied to a site may be roughly equal for both heading and backing fires, as long as additional fuels are not involved. This result can be expected even though the fireline intensity of

the heading fire would be greater. In a backing fire, the released heat energy is concentrated closer to the ground.



Using a driptorch



Heading fire may be used with light fuel loadings

Backing Fire

A backing fire is started' along a baseline (anchor point), such as a road, plow line, stream or other barrier, and allowed to back into the wind. Variations in windspeed have little effect on the rate of spread of a fire burning into the wind. Such fires proceed at a speed of 1 to 3 chains per hour. Backing fire is the easiest and safest type of prescribed fire to use, provided windspeed and direction are steady. It produces minimum scorch and lends itself to use in heavy fuels and young pine stands.

Major disadvantages are the slow progress of the fire and the increased potential for feeder-root damage with increased exposure to heat if the lower litter is not moist enough. When a large area is to be burned, it often must be divided into smaller blocks with interior plow lines (usually every 5 to 15 chains). All blocks must be ignited at about the same time to complete the burn in a timely manner. In-stand winds of 1 to 3 mph at eye level are desirable with backing fires. These conditions dissipate the smoke and prevent heat from rising directly into tree crowns.

When the relative humidity is low, a steady wind is blowing, and fuels are continuous, an excellent burn can be anticipated once the fire backs away from the downwind control line. Under such conditions, however, extra care must be taken to make sure the initial fire doesn't spot across the line.

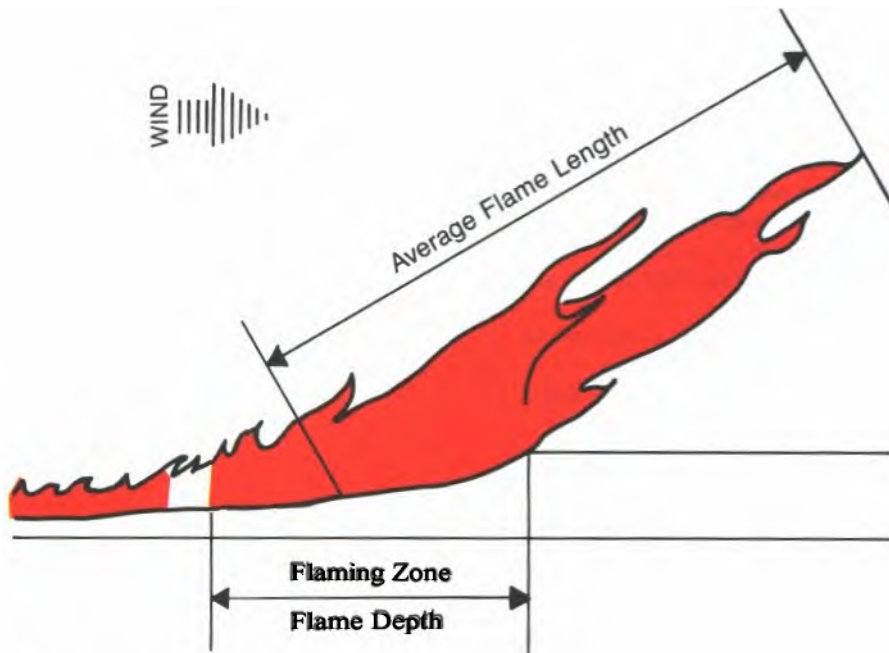

Flame dimensions for a wind-driven fire

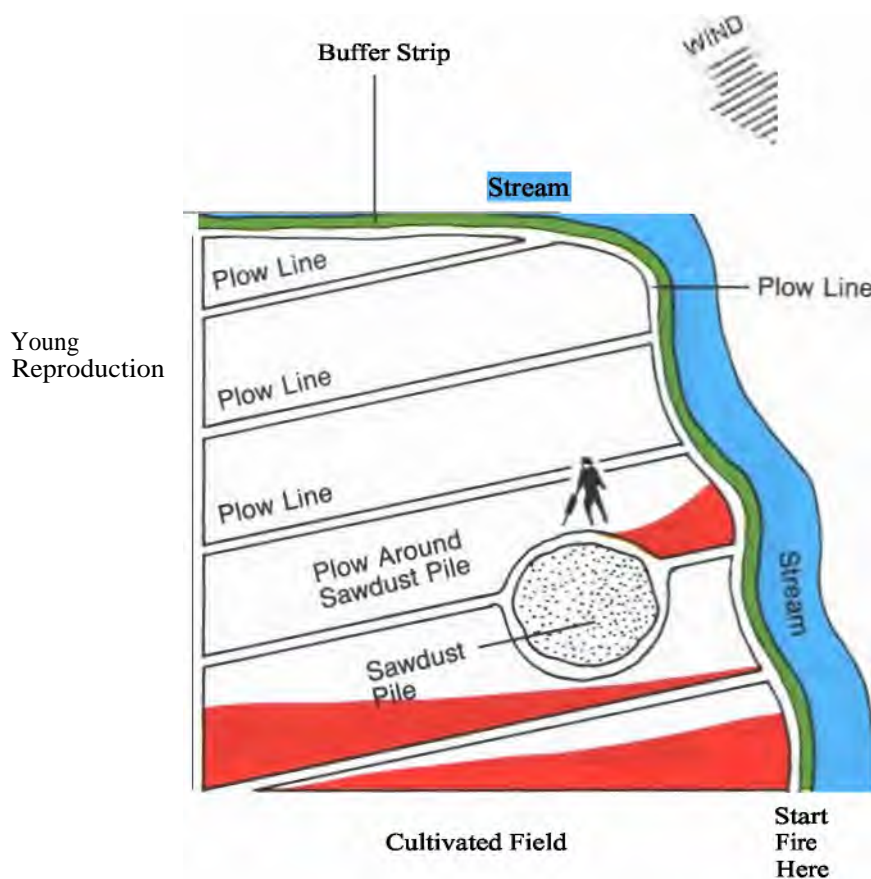

Young
Reproduction

Backing fire technique

Factors Associated with Backing Fires:

- Must be ignited along the downwind control line.
- Use in heavy roughs.
- Use in young stands (minimum basal diameter of 3 inches) when air temperature is below 45°F.
- Normally result in little scorch.
- Costs are relatively high because of additional interior plow lines and extended burning period resulting from slower movement of the fire.
- Not flexible to changes in wind direction once interior lines are plowed.
- Requires steady in-stand winds (optimum: 1 to 3 mph).
- Will not burn well if actual fine-fuel moisture is above 20 percent.
- Requires good fuel continuity to carry well.
- A single torch person can progressively ignite lines.

Strip-Heading Fire

In strip-headfiring, a series of lines of fire are set progressively upwind of a firebreak in such a manner that no individual line of fire can develop to a high energy level before it reaches either a firebreak or another line of fire. A backing fire is generally used to secure the base line and the remainder of the area then treated with strip-heading fires. Strips are often set 1 to 3 chains apart. The distance between ignition lines is determined by the desired flame length. This distance can be varied within a fire to adjust for slight changes in topography, stand density, weather, or the type, amount or distribution of fuel. Compensation for minor wind direction changes can be made by altering the angle of strip fire with the base line. Treat major changes in fuel type separately. An effective method of reducing fire intensity is to use a series of spots or short 1- to 2-foot-long strips instead of a solid line of fire. An added advantage of these short strips or spots is that driptorches will not have to be filled as often. Strip-heading fires permit quick ignition and burnout, and provide for smoke dispersal under optimum conditions. However, higher intensities will occur wherever lines of fire burn together, increasing the likelihood of crown scorch.

Occasionally, on areas with *light* and *even* fuel distribution, a heading fire may be allowed to move over the entire area without stripping to better accomplish the objective(s). This method reduces the number of areas of increased fire intensity that occur each time two fires burn together. **Caution:** Be sure the fire will not escape control. First set a backing fire along the downwind control line and allow it to burn out a strip wide enough to control the heading fire.

Factors Associated with Strip-heading Fires

- Secure the downwind base line before igniting a heading fire.
- Do not use in heavy roughs. Consider alternative techniques if fire-free interval exceeds 3 years.
- Winter use is best because cool weather (below 60°F) helps avoid crown scorch.
- Use in medium-to-large sawtimber. May be used for annual plantation maintenance burns after initial fuel reduction has been accomplished.
- Can be used in "flat" fuels such as hardwood leaves.
- Is a good method for brownspot control.
- Because fire movement is fast, large blocks can be burned.
- Can be used with high relative humidity (50 to 60 percent) and high actual fine-fuel moisture (20 to 25 percent).

- Needs just enough wind to give direction (1 to 2 mph in-stand).
- Cost is lower than other line-firing techniques because fire progress is rapid and few plow lines are required.
- The technique can accommodate wind shifts up to about 45 degrees.
- Flame lengths increase whenever heading fire converges with a backing fire, thereby increasing the possibility of crown scorch.
- A single torch person can progressively ignite strips.
- Do not force a burn on a marginal day at the low end of the prescription window. The fire may burn slowly until after the crew leaves, then pick up intensity and escape.



Flanking Fire

The flanking-fire technique consists of treating an area with lines of fire set directly into the wind. The lines spread at right angles to the wind. This technique requires considerable knowledge of fire behavior, particularly if used by itself. It is used quite often to secure the flanks of a strip-heading fire or backing fire as it progresses. It is sometimes used to supplement a backing fire in areas of light fuel or under more humid weather conditions. It is useful on a small area or to facilitate burning a large area in a relatively short time when a line-heading fire would be too intense.

This method of firing can stand little variation in wind direction and requires expert crew coordination and timing. For safety, all lines of flank fire should be ignited simultaneously and all torch people should keep abreast of one another. If only one or two torch people are available, this technique is usually altered to set the ignition lines 45 degrees into the wind.

In the Piedmont, any ignition line that drops perpendicularly off a ridge creates a flanking fire under no-wind conditions. If several lines are ignited off the end of a ridge or knoll, the pattern looks like a chevron or maple leaf.

Factors Associated with Flanking Fires:

- Always secure downwind base line first.
- Fuel loading should be light to medium—less than 8 tons per acre.
- Wind direction *must* be steady.
- Best used in medium-to-large sawtimber.
- Allows fast area ignition.
- Needs few control lines.
- In areas with a high understory, multiple torch people are needed and coordination is very important. Use radio communications whenever torch people cannot see one another.
- Useful in securing flanks of other fire types.

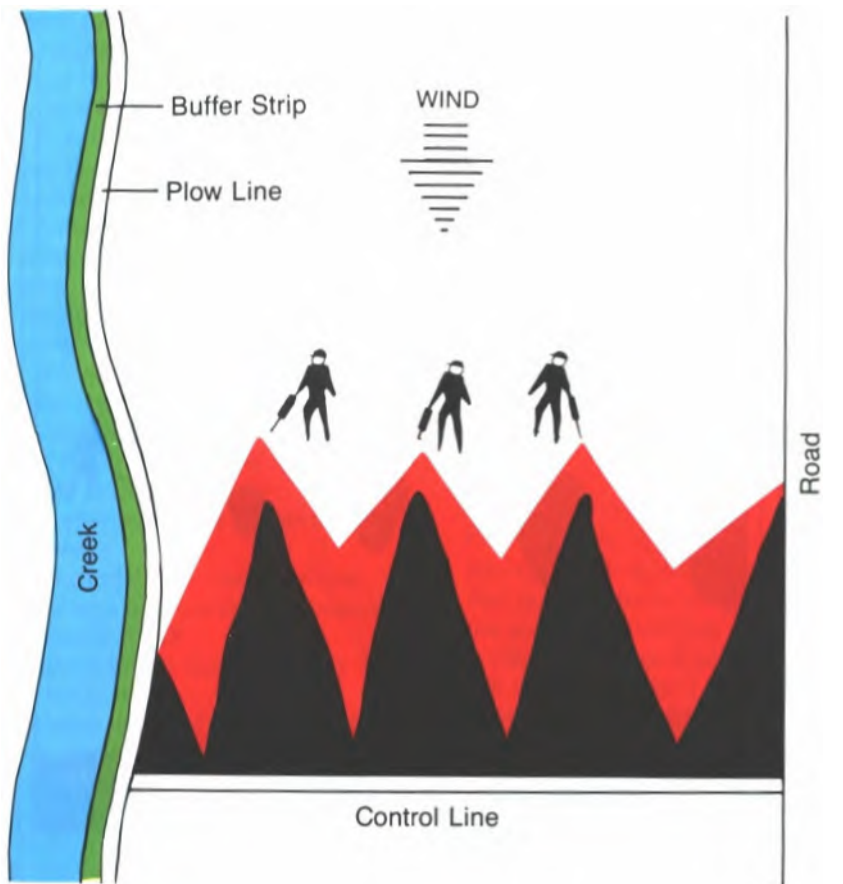

Flanking fire technique

Point Source Fires

A prudent burning boss will often switch from strip-heading fires to point source fires as the day progresses and continuous lines of fire become too intense. When properly executed, a grid of spot ignitions will produce a fire with an intensity much greater than that of a line-backing fire but somewhat less than that of a line-heading fire. Timing and spacing of the individual ignition spots are the keys to the successful application of this method. First a line backing fire is ignited across the downwind side of the block and allowed to back 10 to 20 feet into the block to increase the effective width of the control line. A line of spots is then ignited at some specified distance upwind of the backing fire and the process continued until the whole block has been ignited.

To minimize crown scorch, ignition-grid spacing is selected to allow the spots along a line to head into the rear of the spots along the downwind line before the flanks of the individual spots merge to form a continuous flame front. The merger of successive ignition lines thus takes place along a moving point rather than along a whole line at the same time. Merger along a moving point can be ensured by beginning with a closely spaced square grid (2 chains by 2 chains is recommended). Close spacing between lines helps the individual spots develop, but ensures that the head of one spot will burn into the rear of the downwind spot before the heading fire's potential flame length and intensity are reached. Of course, the closer the spacing, the more merging points you have. You must be aware that a large number of small fires burning simultaneously can produce the same kind of explosive convective energy as a single large fire because too much heat energy is released too rapidly. This situation is discussed more fully under the section on Aerial Ignition.

Rectangular grids with wider spacing between lines than within a line should not be used initially because such a pattern may allow the spots along a line to merge into a line of heading fire before running into the rear of the downwind spots. Once the first few lines have been ignited and fire behavior has been assessed, intensity can be regulated to some ex-

tent by changing the time between ignition points within a line, the distance between points, and the distance between lines. Thus the balancing act between spacing and timing has to be continually adjusted as fire behavior reacts to both tem-

poral and spatial changes in fuel and weather.

Intensity is decreased by widening the interval between ignition points along a line. If fireline intensity is still too high after doubling this interval while maintaining a 2-chain



Point source ignitions

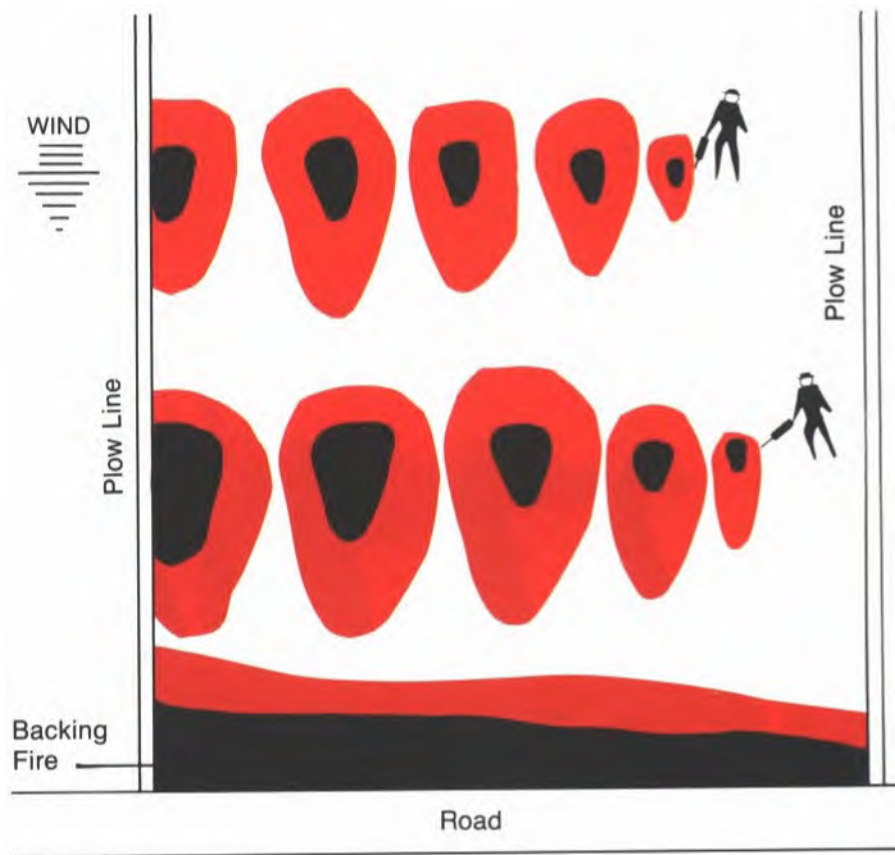

Grid or point source ignition technique

distance between lines, firing should be halted. Allow the area to burn with a backing fire or plow it out. Although intensity at the head of an individual spot is increased by widening the distance between lines, the average intensity of the burn as a whole is usually somewhat lower. Check to see that convergence-zone flame lengths are within tolerable limits, and that other fire behavior parameters appear satisfactory. If everything is within prescription, you can increase both between- and within-line distances. This step will reduce ignition time, and decrease the number of ignitors used. The number of convergence areas with their higher intensities will also be decreased.

Experience to date shows grids up to 4 chains by 4 chains (one ignition point every 1.6 acres) can produce excellent results. The time needed to complete the burn can be reduced by offsetting successive ignition lines by one half of the within-line spacing. The heading fires from one line will then come up between the backing fires on the next line.

Factors Associated with Point Source Fires

- Assume much of the area will be burned by heading and flanking fires and very little by backing fires.
- If conditions are ideal for traditional line-backing fires, point source fires may be too intense.
- Preferred burning conditions include low (1-2 mph) in-stand wind speeds. Wind direction can be variable. Actual fine-fuel moisture should be above 15 percent.
- When underburning, start with a square ignition grid (equal distance between spots within a line and between flight lines). Two chains by 2 chains is often used.
- Always secure the downwind base line first.
- Be careful when underburning stands with a flammable understory or a heavy crown.
- Severe crown scorch is likely if fuel is too dry.
- Under the same weather conditions, fires in Piedmont fuel types tend to spread slower and be less intense than those in Coastal Plain fuel types.
- The usual changes in weather during a typical winter day may require modification of ignition patterns

throughout the day. Burn until fires verge on getting "too hot." Then either quit burning or resort to backing fires only.

- Continually modify the ignition grid to take advantage of topography and changes in understory fuels.
- Costs are low because firing is rapid and no interior control lines need to be constructed.

Aerial Ignition

When ground ignition techniques are used, the downwind spots will usually coalesce and burn out before the whole block has been ignited. In contrast, aerial firing permits ignition of a block to be completed before the downwind spots have burned out. This does not present a problem at the damp end of the prescribed burning window when actual fine-fuel moisture is near 20 percent. Rapid ignition of a block reduces both flying time and the time needed to complete the burn. However, when using aerial ignition techniques under "traditional" ideal burning conditions for line-backing fires with actual fine-fuel moisture near 10 percent, rapid ignition of the entire area can result in an increase in fire intensity to unacceptable levels. You would then have little recourse except to let the area burn out and hope that damage is limited to just a loss in overstory growth.

Some experienced burners start firing early in the day, before the fuel is dry enough to carry fire well. They reduce the distance between spots within a line to less than 2 chains by 2 chains. The increased number of ignitions creates more heat and helps dry the surface fuels, especially when a helitorch is used. The distance between spots must be expanded as the morning progresses and burning conditions improve. Otherwise, the spots will merge laterally forming lines of heading fire that get too intense before reaching the next downwind line of ignition points. The distance between lines can also be increased as necessary to maintain a square ignition grid.

Current aerial ignition techniques can be separated into two major types: the DAID (Delayed Aerial Ignition Device) or ping-pong ball system, and the helitorch or flying driptorch system. The ping-pong ball system utilizes small plastic spheres

containing potassium permanganate. The balls are injected with ethylene glycol and immediately jettisoned before the chemicals react thermally to produce a flame that consumes the ball. The dispensing machine can be mounted in small airplanes or helicopters. The ping-pong ball system works best in continuous fuels or in areas where a mosaic burn pattern is desired.

The helitorch is simply a giant driptorch and drum of gelled gasoline mounted or slung under a helicopter. The helitorch is well suited for discontinuous fuels such as those in clearcuts because this system emits a steady stream of burning fuel globs. It is very difficult to effectively regulate the spacing between these fuel globs. At least one gadget that apparently solves this problem is being marketed. Any helitorch not modified to effectively control the timing between the globs of burning fuel should be considered a line-firing device.

Both types of aerial ignition dramatically reduce the time needed for an area to burn out. Although roughly the same amount of smoke is produced, it is emitted over a shorter period and more of it is entrained in the convection column. Thus, the impact of any adverse air quality effects is much reduced.

Factors Associated with Aerial Ignition

- Rapid firing and burnout allows use of a much smaller prescription window.
- Damp, fine fuels are of critical importance. Actual fine-fuel moistures of 15 to 25 percent are preferable.
- Requires an experienced burning boss to make ignition grid adjustments and to determine when to halt ignition due to conditions.
- Although not likely under prescribed fire conditions, too much heat energy released over too short a period will result in a sudden, dangerous increase in fire intensity.
- Large acreages can be safely burned in a single burning period.
- Many widely dispersed tracts can be burned during a single day.
- A contingency plan is essential in the event the aircraft is reassigned or equipment breaks down during operation.



DAID (Delayed Aerial Ignition Device) dispenser mounted in helicopter



Helitorch in action

Factors Associated with Ping-pong Ball (DA ID) System

- Best suited for continuous fuels or when a mosaic pattern is desired.
- Ignition spacing within and between Tight lines can be easily adjusted.
- A 2 by 2 chain to 4 by 4 chain grid (one ignition point every 0.4 acre to one every 1.6 acres) works well in both palmetto/gallberry and Piedmont fuel types.
- When underburning Coastal Plain fuel types, actual fine-fuel moisture should be 20 to 25 percent (even higher in very heavy fuels) and the air temperature should be low, preferably below 50°F.
- In Piedmont fuel types, actual fine-fuel moisture contents between 10 and 15 percent and air temperature below 55°F work well.
- Make sure no DAID's are mistakenly dropped outside the burn as the helicopter turns at the end of each line.

Factors Associated with Helitorch System

- Not as safe as the DAID system, but less expensive.
- If the torch and fuel tank is slung under rather than attached to the helicopter, a larger crew will be required.
- Creates disposal problems.
- Very difficult to regulate spacing within a flight line.
- Fuel-mixing viscosity is sometimes inconsistent due to temperature changes which, in turn, further aggravate in-line spacing of ignition spots.
- The most efficient firing technique for large, cleared areas with discontinuous fuels, including piled or wind-drowed debris.
- Use extreme caution when underburning Coastal Plain fuel types. Try to keep within-line ignition point interval to at least 2 chains.

Center and Circular (Ring) Firing

This technique is useful on cut-over areas where a hot fire is needed to reduce or eliminate logging debris prior to seeding or planting. It works best when winds, if any, are light and variable. This procedure should never be used for underburning because of the likelihood of severe tree damage as the flame fronts merge.

As with other burning techniques, the downwind control line is the first line to be ignited. Once the base line is secured, the entire perimeter of the area is ignited and the flame fronts allowed to converge. One or more spot fires are often ignited near the center of the area and allowed to develop before the perimeter of the block is ignited. The convection generated by these interior fires creates indrafts that help pull the outer circle of fire toward the center. This firing method can generally be used in any season, and weather conditions are not as critical. However, caution is in order, particularly when the atmosphere is unstable. This type of fire tends to develop a strong convection column which can cause spotting a considerable distance downwind.

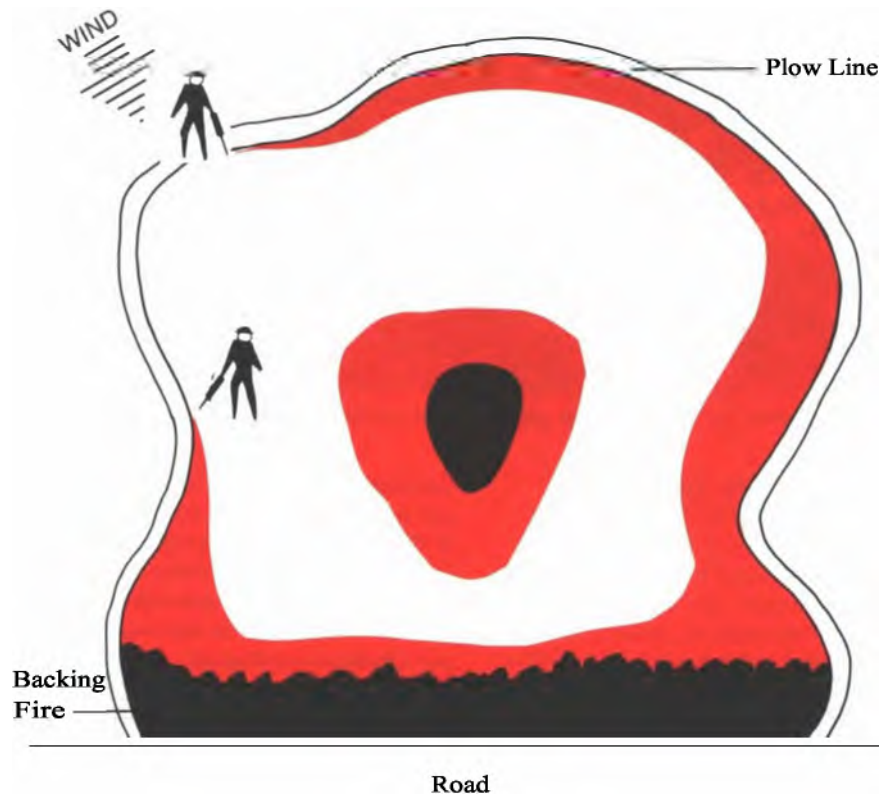

Ignite backing fire first, then center, and then perimeter

Center firing technique

The biggest deterrent to windrow burning, however, is that it causes a high percentage of all smoke incidents. Large volumes of fuel, including larger pieces that contain a lot of moisture, are consumed. However, oxygen for good combustion is lacking, especially in large piles and wide windrows. Large amounts of soil are often mixed in, further compounding the problem. The result is a fire that continues to smolder for days or weeks, creating air quality problems because the smoke produced by smoldering combustion is not hot enough to rise into the atmosphere. The smoke stays near the ground where it cools even more, drifting and concentrating in low areas because of cool air drainage. To make matters worse, the smoke often mixes with humid air to produce fog which further reduces visibility. Coupled with these problems is the fact that the weather changes from day to day making it impossible to predict, and thus manage, the smoke for more than a day or two. For these reasons, air quality regulations prohibit pile and windrow burning in

some areas.

Although it generally costs more to pile than to windrow, piles are preferable to windrows because access within the area is no problem, planting is easier, burning is safer and, most important, smoke problems are significantly reduced since piles burn out much quicker! Generally, piles contain less dirt and dry faster. Burning piles can easily be "humped" to remove any dirt and pushed in to increase consumption. The whole area can then be utilized.

Keep piles small and minimize the amount of soil in them so surface water can pass through, and the debris can dry quickly. Always pile when the ground surface is dry; less soil compaction will take place, and considerably less soil will end up in the piles. Allow fresh logging debris to cure first and to dry after rain. Then "shake" the debris while piling to remove as much soil as possible. If material is piled while green or wet, the centers of the piles take an exceedingly long time to dry. Piles that contain little soil and are constructed to allow some air movement will

Pile and Windrow Burning

The objective of piling logging debris before burning it is to prolong fire residence time on a restricted area so that larger materials have time to be consumed. Some areas will contain an unacceptable amount of large, scattered debris that must be concentrated to ensure consumption. This material should be piled and not windrowed. Windrowing can reduce site quality by removing topsoil. Piedmont soils are also susceptible to compaction from the heavy equipment used, especially during wet weather. Full exposure of the soil to the sun and rain bakes the top layer. Furthermore, the direct force of raindrops will clog soil pores and often results in erosion on steep slopes. The area beneath the windrows is lost to production because the debris is rarely consumed completely and what remains makes planting difficult or impossible. Even when windrows contain breaks spaced every couple of chains, they still present a barrier to firefighting equipment and wildlife.



Tractor-mounted firing device for piled-debris ignition



Piles burn more efficiently than windrows

result in a burn that consumes significantly more of the debris and produces less smoke. More efficient burning and greater heat output will lift smoke higher, reducing smoke concentrations near the ground. Burn when the atmosphere is neutral to slightly unstable, but not unstable enough to create control problems.

Forest managers can take many steps to minimize these debris problems. Much of the larger material left after harvest is cull hardwood, and periodic use of underburns during the rotation will reduce the number of large hardwoods at harvest. Some of the cull material can often be sold or given away as firewood. Sites often can be prepared for seeding or planting by a broadcast burn without piling the debris. Trees should be cut close to the ground, leaving low stumps.

Advances in harvesting equipment and methods have also helped. Large mobile harvesters chip the whole tree, increasing utilization and reducing the need for site preparation. Tree-length logging and gate delimiting

(backing a drag-load of trees between two posts) tend to concentrate much of the debris at the logging deck. Piles created in this manner are generally free of soil (providing logging was suspended in wet weather) and can be burned as is.

Techniques used in burning piled debris are somewhat fixed because of the character and placement of fuel. Traditionally, each pile is ignited along its perimeter, but burnout can be speeded up considerably by igniting the pile center. A helitorch is often used because burning globs of gelled gas penetrate deep into piled fuels and provide a "large" heat source. Tractor-mounted ignition devices that help burning fuel penetrate down toward the center of a pile have also been fabricated.

Factors Associated with Pile and Windrow Burning:

- A large majority of all smoke-related incidents are caused by this type of burning.
- Produces the most smoke of all firing techniques.

- Burns can continue to smolder for many weeks.
- Smoke produced at night tends to stay near the ground.
- Cannot be readily extinguished after ignition. If extinguished, even more effort is required to reignite them the next day.
- Can burn in light or variable winds.
- Usually safe and easy to control, provided piles are not next to the edge of the area and are not left unattended, particularly when burning during periods of high fire danger.
- Piles should be as free of soil as possible.
- Fuel should be dry.
- Burn area should be as small as economically practical.
- Need neutral to unstable conditions for good smoke dispersion — which generally do not occur after sunset.
- Need good mixing heights and transport winds.



Dirt in windrows can aggravate smoke management problems



Windrows can smolder for long periods of time

Smoke Management

Prescribed burning helps achieve many desired resource objectives, but it nevertheless pollutes the air. We therefore have an obligation to minimize adverse environmental effects. If this obligation is disregarded, prescribed burners can be held liable for damages from accidents or problems resulting from their actions. Use the following guidelines to reduce the impact from smoke.

- A. *Define objectives.* — Be sure you have clear resource objectives and have considered both on-site and off-site environmental impacts.
- B. *Obtain and use weather and smoke management forecasts.*

weather and smoke management forecasts are available to all resource managers through State forestry agencies. Be sure to use them. Such information is needed to predict smoke generation and movement as

well as fire behavior. If the forestry weather outlook does not agree reasonably well with the radio/TV forecast, find out why.

- C. *Don't burn during pollution alerts or stagnant conditions.*— Smoke will tend to stay near the ground and will not disperse readily. Many fire-weather forecasters include this in their regular forecasts.
- D. *Comply with air pollution control regulations.* — Know the regulations that apply at the proposed burn site when you make the prescription. Check with your State fire control agency.

E. *Burn when conditions are good for rapid dispersion.*— Ideally, the atmosphere should be thermally neutral to slightly unstable so smoke will rise and dissipate, but not so unstable as to cause a control problem. Again, your local forestry agency can help. Some States use Category Day based on the ventilation rate, but

if the Dispersion Index is calculated for your area, it is a better indicator (see table 1). Reassess a decision to burn when the daytime Dispersion Index value is below 41.

- F. *Use caution when near or upwind of smoke-sensitive areas.* — Burning should be done when wind will carry smoke away from public roads, airports, and populated areas. Do not burn if a smoke-sensitive area is within 1/2 mile downwind of the proposed burn.
- G. *Use caution when smoke-sensitive areas are down drainage.*

smoke. Use aggressive mopup as necessary.

Prescribed Fire Reduces Air Pollution From Wildfires

TABLE 1.—Relationship of Dispersion Index to On-the-Ground Burning Conditions

Dispersion Index	Burning conditions
>100	Very good — Burning conditions may be so good that fires may be hazardous and present fire control problems. Reassess decision to burn.
61 - 100	Good — preferred range for prescription burns.
41 - 60	Generally OK — climatological afternoon values in most inland forested areas fall in this range.
21 - 40	Fair — stagnation may be indicated if accompanied by low windspeeds. Reassess decision to burn.
13 - 20	Generally poor — do not burn. Stagnant if persistent, although better than average for a night value.
7-12	Poor — do not burn. Stagnant during the day, but near or above average at night.
1 - 6	Very poor — represents the majority of nights at many locations.

H. Estimate the amount and concentration of smoke you expect to generate.—This guideline is especially important near highways and populated areas (see table 2). Smoke management guidelines will help you develop this estimate. Some States tie allowable smoke generation to Category Day.

I. Notify your local fire control office, nearby residents, and adjacent landowners.—Notification is common courtesy and is required in most areas. People need to know that your burn is not a wildfire. In addition, the burner will get advance notice of any adverse public reaction and be made aware of special problems, such as respiratory ailments, washday, etc.

J. Use test fires to confirm smoke behavior.—Set these in or adjacent to the area proposed for burning, away from roads or other edge effects.

K. Use backing fires when possible, more completely and produce less smoke. Even though slower and more expensive, they produce fewer pollutants and restrict visibility less.

L. Burn during middle of the day when possible.—Atmospheric conditions for dispersion of smoke will be most favorable.

M. Consider burning in small blocks if Dispersion Index is below 61.—The larger the area being burned, the higher the concentration of particulates put into the air, and the longer the duration of the visibility reduction downwind. However, if weather conditions are good for rapid smoke dispersion, e.g., the Dispersion Index is above 60, it is often better to burn the whole area at one time from a smoke management standpoint.

N. Do not ignite organic soils.—It is virtually impossible to put out an organic soil fire without submerging it in water. It will smoke for weeks despite control efforts, creating severe smoke problems for miles around. Such fires can also reignite surface fuels, resulting in a wildfire.

O. Be very cautious of nighttime burning.—Smoke drift and visibility are very difficult to predict at night. The wind may lessen or stop completely keeping smoke concentrations high in the vicinity of the burn. Burn at night only when you have a definite forecast of optimum conditions. A

TABLE 2--Effect of Smoke Concentration on Visibility

Smoke concentration (micrograms/m ³)	Visibility (miles).
125	2.0 - 8
250	1.0 - 4
500	0.5 - 2
1,000	0.25 - 1

These numbers only valid when relative humidity is below 70 percent.

nighttime smoke patrol is often necessary.

P. Anticipate down-drainage smoke flow.—Atmospheric conditions tend to become stable at night. Stable conditions tend to keep smoke near the ground. In addition, downslope winds generally prevail at night. Thus, smoke will flow down drainage and concentrate in low areas. When relative humidity rises above 80 percent and smoke is present, the formation of fog becomes increasingly likely as moisture condenses on the smoke particles. There seldom are satisfactory solutions to these problems, so they should be avoided entirely whenever possible.

Q. Mopup along roads.—Start mopup along roads as soon as possible to reduce impact on visibility. Extinguish all stumps, snags and logs. Mopup should be particularly aggressive whenever roads are in areas where smoke could travel downslope or up or down a drainage.

R. Have an emergency plan.—Be prepared to extinguish a prescribed burn if it is not burning according to plan or if weather conditions change. Have warning signs available. If wind direction changes, be prepared to quickly contact the local law enforcement agency and to direct traffic on affected roads until traffic control personnel arrive.

*Caution: Check For Down
Drainage Smoke Flow At Night!*

Screening System for Managing Smoke

Most southern States have either voluntary or mandatory smoke management guidelines that should be followed when planning a prescribed burn. Your local State forestry office can advise you of recommended or required procedures. Many of these guidelines use a term called the ventilation rate or ventilation factor which estimates the atmosphere's capacity to disperse smoke. Another way to estimate this capacity is to use the Dispersion Index (see table 1) developed at the Southern Forest Fire Laboratory. This calculated index is better able to incorporate diurnal changes in the lower atmosphere.

If you will be burning in a State that has not issued guidelines, use the *Southern Forestry Smoke Management Guidebook* (see Suggested Reading section, second listing under U.S. Department of Agriculture). This guidebook tells you how to predict smoke concentrations at any distance downwind. An improved and computerized version, called *PRESMOK*, simplifies use of this prediction system. Copies are available from the Southern Forest Fire Laboratory. Use of this smoke screening system does *not* take precedence over State guidelines. The full system cannot be discussed here, but an updated version of the Initial Screening System based on the Guidebook is presented below. This system has five steps: (1) Plot direction of the smoke plume, (2) Identify smoke-sensitive areas, (3) Identify critical smoke-sensitive areas, (4) Determine fuel type, and (5) Minimize risk.

Figure A

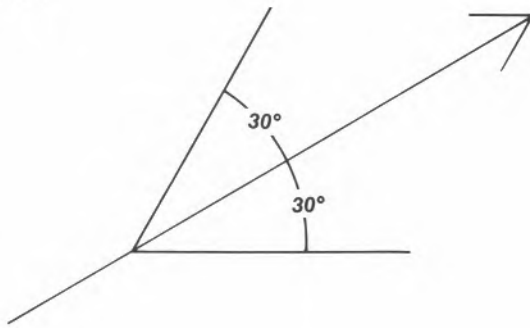
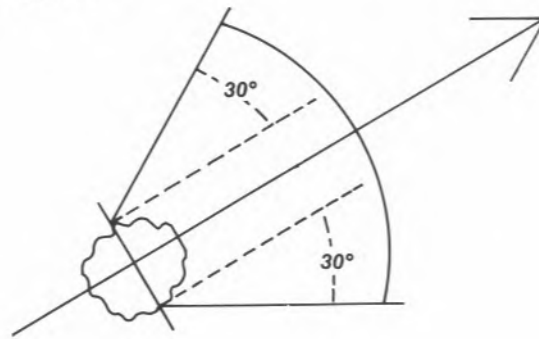

Figure B



Step 1. Plot Direction of the Smoke Plume

- A. Use maps on which the locations of smoke-sensitive areas can be identified. Plot the anticipated downwind smoke movement a distance of: 5 miles for grass fuels regardless of fire type; 10 miles for palmetto-gallberry fuels when using line-backing fires or spot fires; 20 miles for palmetto-gallberry fuels using line-heading fires; 30 miles for all logging debris fires; 5 miles for line backing fires in all other fuel types; and 10 miles for line-heading fires in all other fuel types, or burns of 250 acres or more. First locate the planned burn area on a map and draw a line representing the centerline of the path of the smoke plume (direction of transport wind) for the distance indicated. If the burn will last 3 or more hours, draw another line showing predicted wind direction at completion of the burn.
- B. To allow for horizontal dispersion of smoke as well as shifts in wind direction, draw two other lines from the fire at an angle of 30 degrees from the centerline(s) of observed wind direction (45 degrees if forecast wind direction used). If fire is represented as a spot, draw as in figure A. If larger, draw as in figure B. The result is your probable daytime smoke impact area.
- C. Now go down-drainage for one-half the distance determined above, but do not spread out except to cover any valleys or bottoms. The result is your probable nighttime impact area, providing the burn will be completed at least 3 hours before sunset, and providing the forecast night winds are light and variable.

Step 2. Identify Smoke-Sensitive Areas

- Identify and mark any smoke-sensitive areas (such as airports, highways, communities, recreation areas, schools, hospitals, and factories) within the impact zone plotted in step 1. These areas are potential targets for smoke from your burn.
 - A. If *no* potential targets are found, you may burn as prescribed.
 - B. If the area to be burned contains organic soils that are likely to ignite, do not burn.
 - C. If any targets are found, continue this screening system.

Step 3. Identify Critical Smoke-Sensitive Areas

- A. Critical smoke-sensitive areas are:
 - 1. Those that already have an air pollution or visibility problem.
 - 2. Those within the probable smoke impact area as determined below. If the distance determined in step 1 was:
 - a) 5 miles, any smoke-sensitive area within 1/2 mile is critical, both downwind and down-drainage.
 - b) 10 miles, any smoke-sensitive area within 1 mile is critical.
 - c) 20 miles, any smoke-sensitive area within 2 miles is critical.
 - d) 30 miles, any smoke-sensitive area within 3 miles is critical.
- B. If any critical smoke-sensitive areas are located, **DO NOT BURN** under present prescription!
 - 1. Prescribe a new wind direction that will avoid such targets and Return to the beginning of this screening system, or
 - 2. If smoke-sensitive area is in last half of distance criteria, reduce

- the size of the area to be burned by approximately one half, complete burn at least 3 hours before sunset, and aggressively mopup and monitor, or
- 3. Use an alternative other than burning.

- C. If no critical smoke-sensitive areas are found, or criteria B1 or B2 is met, continue the screening system.

Step 4. Determine Fuel Type

- The smoke produced may vary greatly by type, amount, and condition of fuel consumed.
 - A. From the list below determine which broad type best fits your fuel.
 - I. Grass (with pine overstory)
 - 2. Light brush
 - 3. Pine needle litter
 - 4. Palmetto-gallberry
 - 5. Windrowed logging debris
 - 6. Scattered logging debris or small dry piles
 - B. Review fuel categories or combinations.
 - 1. If the fuel type is described by one of the above categories, continue.
 - 2. If your fuel type is not comparable to any of the above, pick the fuel type for which fire behavior and smoke production most nearly compare with yours and proceed with **EXTREME CAUTION** on the first few burns.
 - C. If the fuel type is windrowed logging debris, and you have identified smoke-sensitive areas, **DO NOT BURN** under present prescription. Smoke production is great and can last for weeks.

1. Prescribe a new wind direction to avoid *all* smoke-sensitive areas and return to the beginning of the system.
 2. If you cannot avoid all smoke-sensitive areas, you will need a better procedure than this simple screening system. Refer to the *Southern Forestry Smoke Management Guidebook* or use *PRESMOK*.
- D. If the fuel type is scattered logging debris or small, essentially dirt-free, dry piles, the following conditions should be met:
1. Size of area to burn less than 100 acres.
 2. No major highways within 5 miles down drainage.
 3. No other smoke-sensitive areas within 3 miles down drainage.
 4. If relative humidity is predicted to stay below 80 percent and surface winds above 4 m.p.h. all night, the distances in 2 and 3 above can be cut in half.
- E. If your comparable fuel type is one listed in 4A above, determine your total per-acre fuel loading. See below or *Southern Forestry Smoke Management Guidebook* for tables to assist you.
1. If less than 10 tons per acre, continue. Generally, the *total* fuel loading will be less than 10 tons in the fuel types listed below when age of rough is:
 - a. Grass (with pine overstory), any age. Also wheat fields and other agricultural burns.
 - b. Light brush, 7 years old or less (10 years if basal area is under 100 square feet per acre).
 - c. Loblolly pine with
 - a. palmetto-gallberry understory, 7 years or less if basal area is under 150 square feet per acre.
 - b. little or no understory, 15 years or less if basal area is under 150 square feet per acre.
 - d. Slash pine with
 - a. palmetto-gallberry understory, 5 years or less if basal area is under 150 square feet per acre.
 - b. little or no understory, 8 years or less if basal area is under 150 square feet per acre.
 2. If greater than 10 tons per acre, refer to the *Southern Forestry Smoke Management Guidebook* or double the distance determined in step 1A. Use 1 1/2 times the distance if close to 10 tons.

Step 5. Minimize Risk

To meet your smoke management obligations when any smoke-sensitive area may be affected by your burn, you *must* meet all of the following criteria to minimize any possible adverse effects.

- Height of mixing layer (mixing height) is 1,650 feet (500 meters) or greater.
- Transport windspeed is 9 mph (4 meters per second) or greater.
- Background visibility is at least 5 miles within the plotted area.
- If rough is older than 2 years, use a backing fire. If burn can be completed 3 hours before sunset, or if no smoke-sensitive areas are located in the first half of the impact area, other firing techniques can be used.
- Promptly mopup and monitor to minimize smoke hazards.
- If a smoke-sensitive area is in the overlapping trajectory of two smoke plumes, it should be 1 mile from either source (2 miles if one is from logging debris).
- For night burns, backing fires with surface windspeed greater than 4 mph and relative humidity under 80 percent should be prescribed.
- If it appears that stumps, snags, or logs may cause a residual smoke problem, take steps to keep them from burning. If they do ignite, extinguish them.
- Daytime value of the Dispersion Index between 41 and 60 is adequate for small fires and low levels of burning activity. As either size of individual fires or level of burning activity increases, the Dispersion Index value should also increase.

Many variables affect the behavior and resulting smoke from a prescribed burn. The above system works best in flat terrain and was not designed for use in mountainous country. It does not attempt to consider all the variables: it can only offer broad guidelines. If your prescribed fire complies with all conditions in these five steps, you should be able to safely burn without causing a smoke problem. If you have any marginal answers, areas that are especially sensitive to smoke, heavy fuel loadings or wet fuels, use the prediction system mentioned in the *Southern Forestry Smoke Management Guidebook*. You must make the final judgement.

CAUTION: Be Sure Atmospheric Conditions Are Conducive To Good Dispersion!

Planning the Prescribed Burn

The first step to a successful prescribed burn is a stand-by-stand analysis of your forest lands. Determine the needs of each stand and what actions should be taken to meet these needs. Prescribed fire as well as other alternatives should be addressed here and a decision reached regarding the preferred treatment.

Prescription burning is a highly technical job requiring knowledge of fire behavior, suppression techniques, and environmental effects of fire. Well in advance of the burning season, scout stands that may need a fire treatment and choose those to burn. Overplan the number of acres to be burned by 10 to 25 percent so substitutions can be made if necessary, and so additional areas can be burned if favorable weather continues. The number of suitable burning days varies widely from year to year and the acreage that can be burned on a

given day can be increased dramatically if aerial ignition is used. If you have several blocks to burn, set priorities. Specifically designate any planned burns that require exacting weather conditions. Considerations include heavy fuels, small trees, potential smoke problems, etc. Indicate all blocks to be burned on an administrative map. When the burns are completed, record the dates on the map.

A written prescribed-burning plan prepared by a knowledgeable person is needed for each area to be burned. Complete the plan before the burning season and be prepared to burn when the prescribed weather occurs. Some plans may be quite short and simple while others will be complex. Individual blocks can vary from a few acres to over 1,000, but topography, and amount and type of fuel in a unit should be similar. Your plan can con-

sist of a series of blocks in the same compartment or management unit as long as the same objectives apply and the fuel is similar.

Break large areas into 1-day burning blocks or smaller areas. Use existing barriers such as roads and creeks as possible, but be sure these barriers are effective at the time of the burn.

The Written Plan

A prepared form with space for all needed information is best. The form will serve as a checklist to be sure you have not overlooked some aspect or potential impact. Sample forms for both understory burns and postharvest burns can be found on pages 34, 35, and 36. The "simple" form can be used on small burns within a large landholding that does not contain public roadways. Contents of the written plan should include:

TABLE 3 — Effects of Age of Rough on Some Common Fire Parameters

Parameter	Age of rough (years)					
	1	2	4	8	16	
Litter fuels (tons/ac)	1.5 - 3	2.5 - 4.5	4 - 7.5	5.5 - 12	6.5 - 15	
Fireline intensity (Btu/sec/ft)	B ¹ H ²	8 - 15 30 - 60	12 - 25 50 - 90	20 - 35 80 - 145	25 - 65 Outside Rx underburning window	30 - 75
Flame length (feet)	B H	0.5 - 1.5 1.5 - 2	1 - 2 2 - 2.5	1.5 - 2.5 2.5 - 3.5	2 - 3 Outside Rx underburning window	2 - 3.5
Scorch height ³ (feet)	B H	<5 6 - 10	<5 - 5 9 - 14	<5 - 7 13 - 19	5 - 11 Outside Rx underburning window	6 - 12

Assume a 20-year-old southern pine plantation on the Coastal Plain with no understory present. Table values will increase as the amount of understory increases. In the Piedmont and mountains, an understory is likely to have an opposite effect except during severe drought.

¹ = Backing fire with rate-of-spread of 100 feet per hour and fuel consumption of 60 percent.

² = Heading fire with rate-of-spread of 660 feet per hour and fuel consumption of 40 percent.

³ = Ambient temperature of 50°F and windspeed of 2mph. Lower temperatures and higher windspeeds will decrease scorch height.

Simple Understory Prescribed Burning Unit Plan

Landowner _____ Permit no. _____
 Address _____ Phone No. _____
 S ____ T ____ R ____ County _____ Acres to Burn _____ Previous burn date _____
 Purpose of burn _____
 (Draw map on back or attach)

Stand Description

Overstory type & Size _____ Height to bottom of crown _____
 Understory type & height _____
 Dead fuels: description and amount _____

Preburn Factors

Manpower & equipment needs _____
 List smoke-sensitive areas & locate on map _____
 Special precautions _____

 Estimated no. hours to complete _____ Passed smoke screening system _____
 Adjacent landowners to notify _____

Weather Factors:

Desired Range	Predicted	Actual
Surface winds (speed & dir.) _____	_____	_____
Transport winds (speed & dir.) _____	_____	_____
Minimum mixing height _____	_____	_____
Dispersion/stagnation index _____	_____	_____
Minimum relative humidity _____	_____	_____
Maximum temperature _____	_____	_____
Fine-fuel moisture (%) _____	_____	_____
Days since rain _____ Amount _____	_____	_____

Fire Behavior:

Desired Range	Actual
Type fire _____	_____
Best month to burn _____	Date burned _____
Flame length _____	_____
Rate of spread _____	_____
Inches of litter to leave _____	_____

Evaluation:

Immediate	Future
Any escapes? _____ Acreage _____	Evaluation by _____
Objective met _____	Date _____
Smoke problems _____	Insect/disease dam. _____
% of area with crown discoloration of _____	Crop tree mortality _____
5-25% ____ 26-50% ____ 51-75% ____ 76%+ ____	% understory kill _____
Live crown consumption _____	Soil movement _____
% understory veg. consumed _____	Other adverse effects _____
Adverse publicity _____	_____
Technique used OK _____	Remarks _____
Remarks _____	_____
_____	_____
_____	_____
_____	_____
_____	_____

Prescription made by _____
 Title _____ Date ____ / ____ / ____

Understory Prescribed Burning Unit Plan

Prepared by _____ Signature _____ Date _____ Permit no. _____
 State _____ County _____ District _____ Comp't _____
 Burning unit no. _____ S _____ T _____ R _____ Gross acres _____ Net acres _____
 Landowner _____ Address & phone no. _____
 Person responsible & how to contact day & night _____
 (Draw map on back or attach)

A. Record of Previous Burning: Date _____ Fire type _____ Results _____

- B. Description of Stand:**
1. Overstory: Type, density, size _____ Height to bottom of crown _____
 2. Understory: Type, density, height _____
 3. Dead fuels: Type, density, age, volume _____
 4. Soil type and topography _____

C. Purpose(s) of Burn: _____

D. Specific Objectives: _____

- E. Preburn Factors:**
1. Chains to plow (see map): Exterior _____ Interior _____ Total _____
 2. Chains to fire (see map): Exterior _____ Interior _____ Total _____
 3. Crew size: _____ Equip. needs _____
 4. Estimated tons/acre _____ Total tons to be burned _____
 5. Ignition procedure (see map) _____
 6. Passed screening system? _____ Special precautions _____
 7. Notify: _____
 8. Regulations that apply _____
 9. List smoke-sensitive areas & critical targets (see map): _____

F. Weather Factors:

	Desired Range	Predicted	Actual
1. Surface wind (speed & dir.)	_____		
2. Transport wind (speed & dir.)	_____		
3. Stability/stagnation index	_____		
4. Minimum mixing height	_____		
5. Dispersion index	_____		
6. Minimum relative humidity	_____		
7. Maximum temperature	_____		
8. Fine-fuel moisture	_____		
9. Days since rain _____ Amount _____			
10. Burning Index _____ Drought Index _____			

G. Fire Behavior:

	Desired Range	Actual Range
1. Type fire	_____	
2. Best month to burn _____ Date burned _____		
3. Time of day to start _____ Time Set _____		
4. No. hours to complete _____ Completed _____		
5. Flame length _____		
6. Rate of spread _____		
7. Fireline intensity _____		
8. Inches of litter to leave _____ Litter left _____		

H. Evaluation Immediately After Burn:

	Future Evaluation:
1. Acres burned _____ Evaluation by _____	
2. Spotting _____ Distance _____ Date made _____	
3. Any escapes _____ Insect/disease dam. _____	
4. Objectives met _____	
5. Smoke problems _____ Crop tree mortality _____	
6. % understory veg. consumed _____	
7. % of area with crown discoloration of _____ % Understory kill _____	
5-25% 26-50% 51-75% 76%+ _____ Soil movement _____	
8. Live crown consumption _____ Other adverse effects _____	
9. Adverse publicity _____	
10. Remarks _____ Remarks _____	

Postharvest Prescribed Burning Unit Plan

Prepared by _____ Signature _____ Date _____ Permit no. _____
 State _____ County _____ District _____ Comp't _____
 Burning Unit No. _____ S _____ T _____ R _____ Gross acres _____ Net acres _____
 Landowner _____ Address & phone no. _____
 Person responsible & how to contact day & night _____
 (Draw map on back or attach)

A. Description of Area:

1. Natural stand or plantation _____ Stand age _____ Harvest date _____
2. Clearcut _____ Harvest method _____ Pine basal area removed _____
3. Organic soil _____ Hardwood basal area _____ Hardwoods utilized _____
4. Unmerchantable trees felled _____ Snags felled _____ Debris evenly distributed _____
5. Debris (light, medium or heavy) _____ Brush (light, medium or heavy) _____
6. Herbaceous fuels (light, medium, heavy) _____ Herbaceous fuels continuous _____
7. Herbicide used _____ Date applied _____ / _____ / _____
8. Drum chopped _____ Single or Double Pass _____ Date Completed _____ / _____ / _____
9. Windrowed and/or piled _____ Date piled _____ / _____ / _____ Piled when wet _____
10. Pile or windrow dimensions: Ht. _____ Width (dia.) _____
11. Windrow break interval _____

B. Preburn Factors and Desired Fire Intensity:

1. Areas to exclude: _____
2. Chains to plow (see map): Exterior _____ Interior _____ Total _____
3. Chains to fire (see map): Exterior _____ Interior _____ Total _____
4. Equipment needs _____
5. Crew size _____ Type of fire _____ Type of ignition _____
6. Ignition procedure (see map): _____
7. No. of hours to complete _____ Tons/acre to consume _____ Litter to leave (in.) _____
8. Special precautions: _____
9. Notify: _____
10. Regulations that apply _____
11. Passed screening system? _____ List smoke-sensitive areas, critical targets & locate on map: _____

C. Weather Factors:

	Desired Range	Predicted	Actual
1. Surface wind (speed & dir.)	_____	_____	_____
2. Transport wind (speed & dir.)	_____	_____	_____
3. Mixing height	_____	_____	_____
4. Dispersion Index (or comparable)	_____	_____	_____
5. Relative humidity (%)	_____	_____	_____
6. Temperature (oF)	_____	_____	_____
7. Fine-Fuel moisture (%)	_____	_____	_____
8. 10-hr. fuel moisture (%)	_____	_____	_____
9. Days since rain _____ Amount _____	_____	_____	_____
10. Burning Index _____ Drought Index _____	_____	_____	_____
11. Best month to burn _____	_____	Dates burned _____	_____
12. Time of day to start _____	_____	Time set _____	_____

D. Summary of Burn:

1. Type fire & ignition _____
2. All piles, windrows & logging decks ignited _____
3. % of area burned _____ Did area between piles burn? _____
4. Spotting frequency _____ Distance _____ firebrand material _____

E. Evaluation Immediately After Burn:

1. Any escapes: Number _____ Adjacent to burn area? _____ Acres involved _____
2. Hours to burnout: Active flaming _____ Smoldering _____ Total hours _____
3. % understory veg. consumed _____ Depth of litter remaining (in.) _____
4. % material < 3" dia. consumed _____ Did piled debris burn down? _____
5. Objectives met _____
6. Adverse publicity _____
7. Smoke problems _____
8. Remarks _____

F. Future Evaluation (Date, signature and remarks) _____

Required Signatures

Provide spaces for signature(s) of person(s) who prepared the plan. This identifies the people who know the most about the plan.

Purpose and Objective(s)

Include in the written plan the reason(s) for prescribing a fire. Examples include: prepare seedbed, control insects or disease, reduce hazard, improve wildlife habitat, control understory, improve forage, increase accessibility, and enhance aesthetics. In addition, give a specific quantifiable objective. State exactly what the fire is to do — what it should kill or consume, how much litter should be left, etc. Also concisely describe the expected fire behavior, including the desired range in flame length and fireline intensity. In case prescribed weather conditions do not materialize, this description may allow the objective(s) to still be achieved by varying the firing technique. Such information will also be useful in determining success of a burn.

Map of the Burning Unit

A detailed map of each burning unit is an important part of the burning plan. The map should show the boundaries of the planned burn, adjacent land owners, topography, control lines (both existing and those to construct), anticipated direction of the smoke plume, smoke-sensitive areas, holding details, and other essential information. Plowed control lines are often not necessary. Consider expanding the planned burn to employ existing fire-breaks and natural barriers. For example, use fuel type boundaries such as occur near creek bottoms where the fire will go out as it encounters fuels with a higher moisture content. Show areas that should be excluded or protected such as improvements, young reproduction, sawdust piles, etc. Subdivide each area to be burned into logical, 1-day burning blocks, or smaller areas if smoke management needs dictate.

Equipment and Personnel

List equipment and personnel needed on site and on standby. Assign duties.

Fire Prescription

The amount of fuel, weather conditions and desired intensity of the burn will determine the firing technique



Make a prescribed fire plan for each area

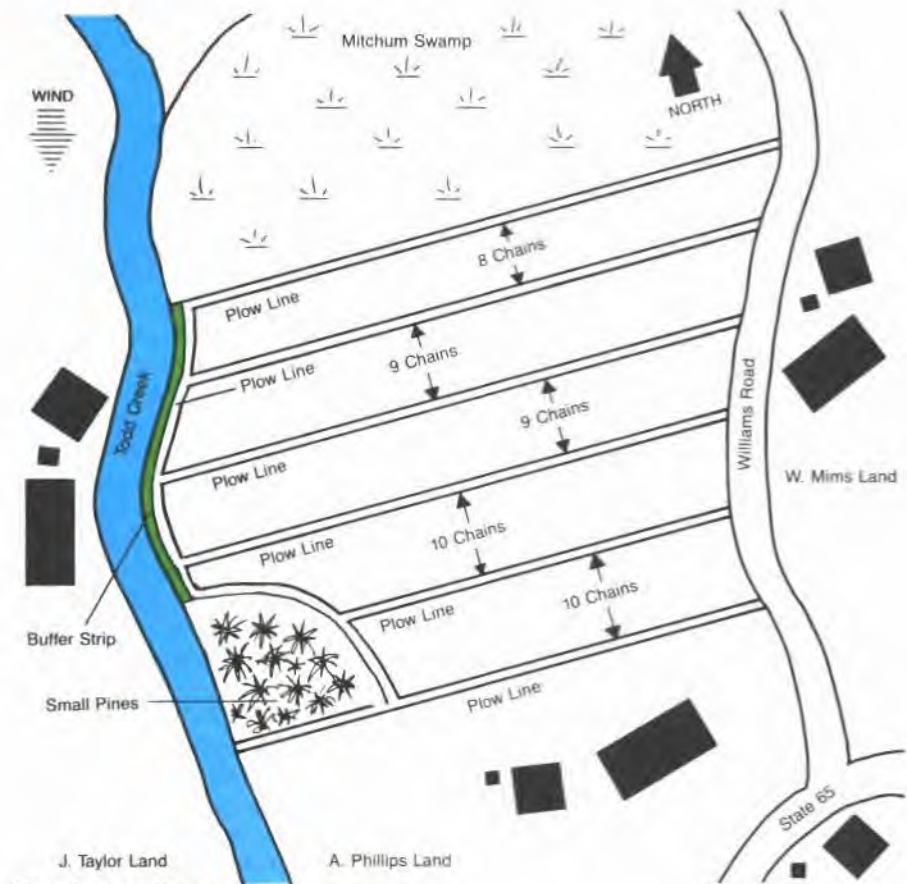

Burning unit map

and ignition pattern to use. Species involved and height of overstory will determine the maximum intensity that can be tolerated. Where large amounts of fuel are present, cooler burns can be accomplished by burning when humidity and fuel moisture are near the high end of the range so a smaller

fraction of the fuel will burn. Lower temperatures are desirable with more intense fires, especially when understory fuels are tall.

A series of user-friendly computer programs called *BEHAVE* has been developed to predict the behavior of a fire. They are based on a specific set

of fuel data and prescribed weather conditions. These programs will run on a hand-held calculator with a fire behavior CROM (Custom Read Only Memory). You can use them in the field to make instant decisions as burning conditions change. A version called *MICRO BEHAVE*, compatible with IBM PCs, is also available at very low cost from Forest Resources Systems Institute (FORS), Courtview Towers, Suite 24, 201 N. Pine Street, Florence, AL 35630; telephone (205) 767-0250.

Always think about smoke management. Make sure your burning plan passes a smoke management system.

Season

Winter — Most understory burning is done during the winter dormant season. Acceptable relative humidity, temperature, fuel moisture, and steady, persistent winds most often occur then.

Spring — More variable weather and generally higher fire danger dictate smaller burns in the spring. Check with local wildlife specialists to avoid periods when prescribed burning could harm nesting wildlife. Pine buds are more exposed and thus more susceptible to heat damage during elongation.

Summer — Hot weather during the summer means much less heat is needed to raise the temperature of plant tissue to lethal levels. For this reason, summer burns are used to kill undesirable hardwoods — usually a series of burns after an initial winter burn. Care must be taken not to severely scorch overstory crowns. Postharvest burns to dispose of logging debris can be conducted year-round, but conditions are especially good in mid to late summer because the high ambient temperatures help dry out the larger materials.

Fall — Exercise special care when burning in early fall just prior to the dormant season. Both loblolly and slash pines are more likely to die if severely scorched or root damaged at this time.

Time of Day

Normally, plan burning operations so the entire job can be completed within a standard workday. Prescribed fires usually are ignited between 10 a.m. and noon, after sunshine has evaporated any early morning dew. If an inversion occurred the previous night, wait until daytime heating eliminates it before igniting the fire. If the forecast is for poor nighttime dispersion, halt ground ignition before 3 p.m. standard time (ST). Halt aerial ignition before 4 p.m. ST, to allow adequate time for the fire to burn out before atmospheric dispersion conditions deteriorate.

Burning conditions are usually better during the day than at night because windspeed is higher and wind direction steadier. Smoke management is also much easier during the day. At night smoke tends to stay close to the ground and collect in depressions. Also, relative humidity usually increases at night, resulting in spotty burning and an increased likelihood that fog will form.

However, on winter nights when a strong cold front moves across an area, winds remain strong and persistent and relative humidity does not rise greatly. These conditions can provide good prescribed burning weather, especially when cooler temperatures are needed. Whenever night burning is done, keep a close check on wind, humidity, and smoke drift.

Firing Plan

Key parts of a successful prescribed burn are plans for firing and holding a burn. This plan should consist of a narrative section and a detailed map. The burning unit map is ideal for this purpose because it already contains much pertinent information. Add the following items:

- Firing technique, ignition pattern, and planned ignition time.
- Manpower and equipment needed, and planned distribution for setting, holding, patrolling, and mopping up the fire and managing the smoke.
- Location and number of reinforcements and equipment that can be mobilized rapidly if fire escapes.
- Instructions for all supervisory personnel, including complete description or illustration of assignment, and forces needed to fire out, hold, and mop up the fire.

Alternative Prescriptions

Consider alternative sets of weather conditions (wind, relative humidity, and/or fuel moisture) and methods of burning that will produce a fire of about the same intensity and accomplish the desired objectives. Two separate burns may be necessary to eliminate heavy volumes of fuel without damage to the overstory.

Preparation Work and Protection of Sensitive Features

Include fire lines to be constructed, snags to be lined or felled, special features to be protected and the installation of any monitoring equipment. Give instructions for the protection of sensitive areas. Consider historical and archeological sites, streams, habitats of threatened and endangered species, and fragile soils.

Notification of Intent to Burn

List the names and telephone numbers of the local State fire protection officer and other officials who should be contacted prior to the burn. Make direct contact with all homes and businesses in the area likely to be impacted by the burn. Offer to evacuate anyone with respiratory problems during the burn. Put them up in a local motel if necessary. Consider written notification explaining the reasons for the burn and encouraging individuals with respiratory ailments to contact you — include a 24 hour telephone number. Establish responsibility for burn-day contacts and how they will be made. Consider a newspaper article describing the reasons for the burn if you expect to produce lots of smoke or anticipate any negative reactions.

*Establish Burn Acreage Goals
But NOT Quotas!*

Impact of Smoke

List any sensitive areas near to, downwind, or down drainage of the burn. Include smoke management strategies of avoidance, emission reduction, dispersal, or all three, to minimize any adverse smoke impacts. Attach the smoke management plan (e.g. screening system calculations) as part of the burning plan.

Legal Requirements

List any legal requirements that might apply, and what the prescribed burner must do to comply. Remember, the person who conducts the prescribed burning operation may not be the one who made the analysis and prepared the prescription. Follow all applicable statutes, regulations, and agency procedures. Needs for a written prescribed burning plan, documentation of deviations from the plan, and good judgment cannot be overemphasized. Erroneous forecasts, unforeseen local influences, and accidents occur despite our best efforts to prevent them. Proper documentation will help establish that the prescribed fire was conducted in a prudent and professional manner. If a prescribed fire results in damage or bodily harm and you cut corners, neglected any mandatory requirements, or acted with disregard to the welfare of others, you are likely to be held responsible, regardless of whether compliance would have changed the outcome. For more information see the summary article, *Legal Implications of Prescribed Burning in the South* by William C. Seigal, listed in the Suggested Reading section.

Escaped-Fire Plan

Identify potential fire escapes and specify actions to take should such occur. Designate who will be in charge of suppression action and what personnel and equipment will be available.

Control and Mopup

A plan must include necessary safeguards to confine the fire to the prescribed area and reduce smoke impact. Mopup promptly and completely. Emphasize protection of all adjacent land. Consider and make plans for any variation in forecasted weather that may change a prescribed fire into a damaging wildfire, increase the pollution in smoke-sensitive areas, or create visibility problems on adjacent roads.

Evaluation

Include space for a written evaluation of the prescribed burn. A record of actual weather conditions, behavior of the fire, and total environmental effects of the burn is essential. This information is used to determine the effectiveness of the prescribed burn and in setting criteria for future burns.

At the beginning of the prescribed burn, record windspeed and direction, fuel moisture, humidity, burning index, temperature, days since and amount of last rain, and dampness of soil and lower litter. Also record fire behavior data such as type of fire used, length of flames, and forward rate of spread. Continue to record applicable weather and fire-behavior parameters at 2- to 3-hour intervals throughout the burn. After the burn, record amount of crown scorch, consumption of brush, litter, and duff, and any other evidence of fire intensity such as unburned areas, exposed mineral soil, and cracks in bark or cupping on the lower bole due to bark consumption. Also include a short narrative on success of the burn.

*Give Prescribed Burning FIRST
Priority When Weather Conditions
Are Favorable*

*Prescribed Fires Often Behave
Erratically At Edges Of Openings*

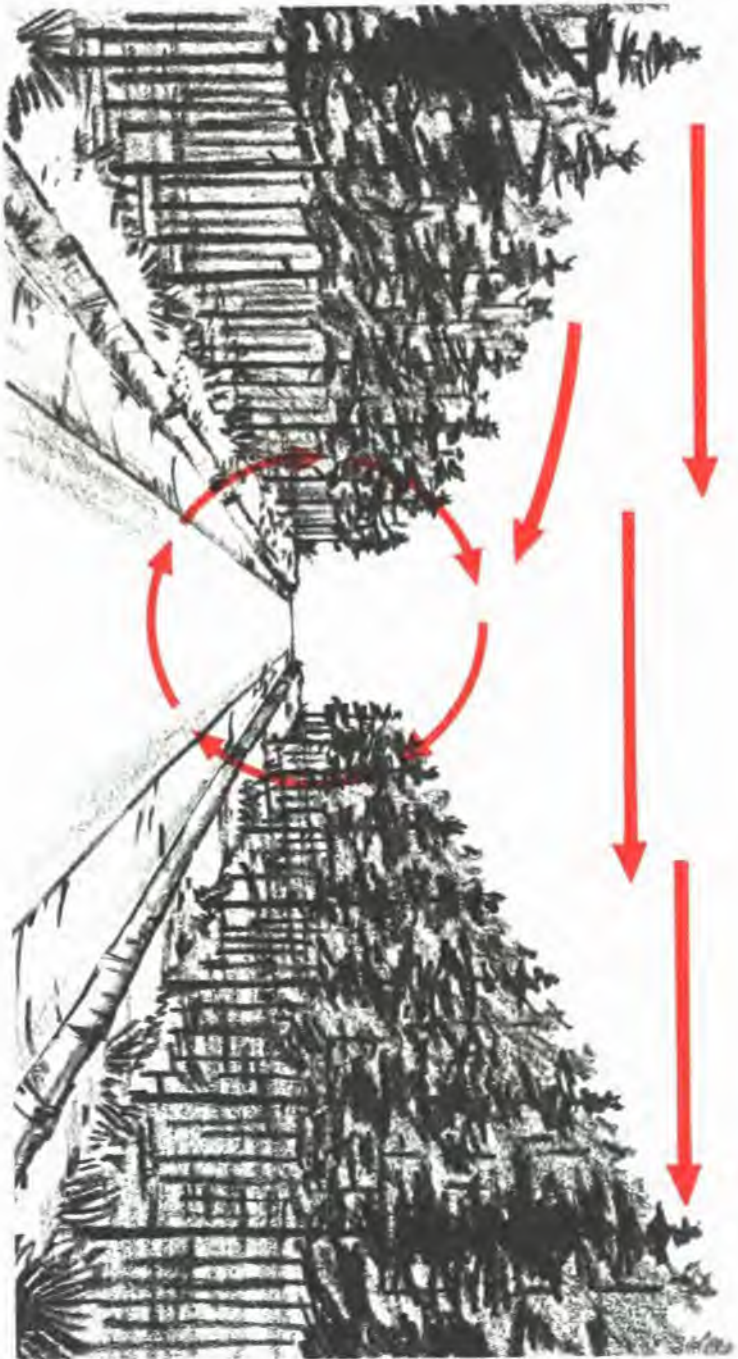

Eddies caused by forest openings

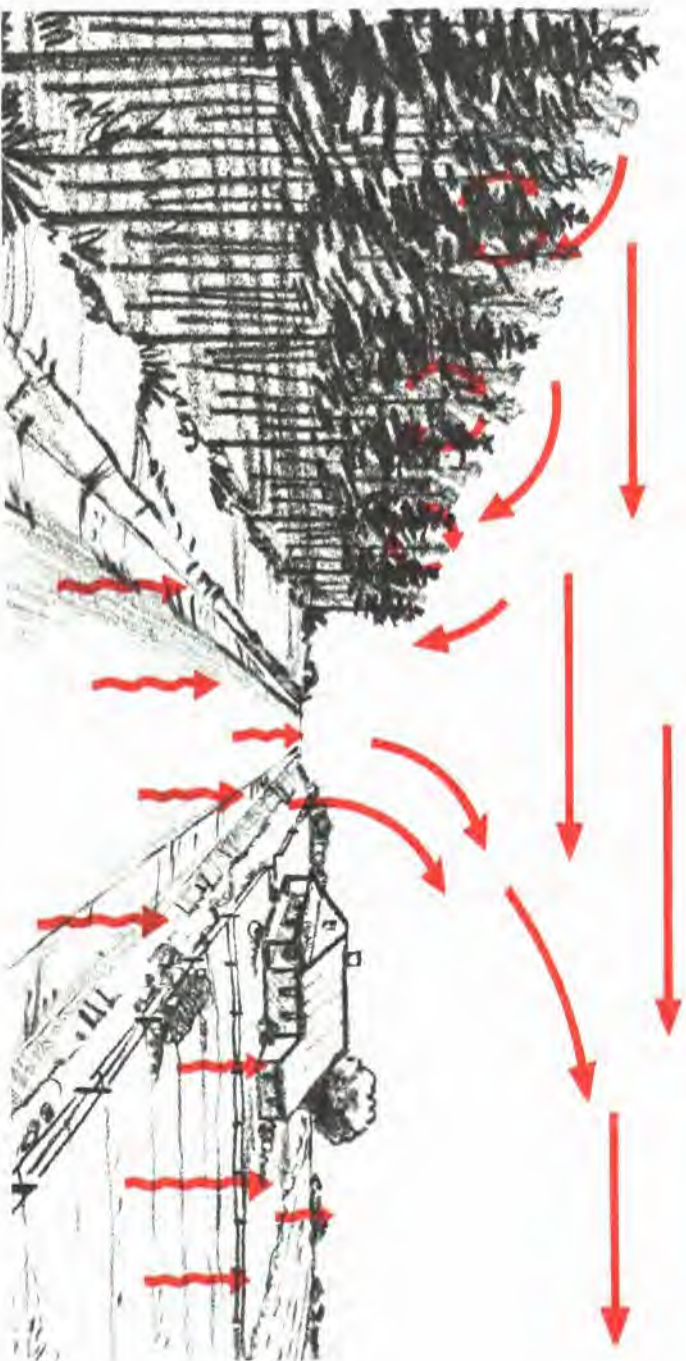

Preparing for the Prescribed Burn

Steps to Be Considered

Good preparation is the key to successful burning. It is essential in realizing maximum net benefits at acceptable cost. Preparation consists of all steps necessary in making the area ready for firing and of having all needed tools and equipment in operating order and ready to go.

This preburn work is often done by a crew consisting of a leader, a tractor operator, and a cleanup person. The leader should be trained and experienced in prescribed fire. The job is to locate and establish control lines to best accomplish the objectives of the burning plan. To do this job skillfully, the leader must have personal knowledge or information available about:

- Weather elements involved
- Fire behavior
- Smoke management
- Amount and type of fuel on the area
- Location of natural and manmade fire barriers
- Degree of risk and hazard present
- Burning technique and intensity of fire to be used
- Burning objectives for the particular area
- Restrictive measures dictated by law or local custom
- Fire suppression safety
- Location of any improvements which could be endangered
- Areas within the prescribed unit that may need to be excluded from fire, such as:
 - areas with extreme mopup or breakover potential (sawdust piles, snags, etc.)
 - highly scenic areas
 - highly erodible areas
 - streamside zones
 - areas harboring special-quality wildlife or plant community habitat that would be damaged by fire
 - desirable hardwood areas
 - timber and grass areas susceptible to fire damage



Establishing a control line in heavy rough

All site-specific information should be included in the written prescription. Before starting work, the leader should inspect the area by walking over it and should give safety instructions to the crew.

Establishing Control Lines

- Plow in advance of burning, preferably after leaf fall, to reduce effect of fallen material on prepared lines.
- Use natural barriers such as streams, logging roads, or cultivated fields whenever possible.
- Hold plowlines to a minimum, keeping them shallow and on the contour as much as possible in hilly country. Consider igniting from wet lines. Use skid trails and logging roads where feasible.
- Keep control lines as straight as possible. Bend them around excluded areas, avoiding abrupt changes in direction.
- Avoid rock outcrops and boggy ground.
- Double or widen plow lines at hazardous places.

- Subdivide large areas into logical 1-day burning jobs.
- Avoid leaving dense timber stands or heavy fuel pockets near lines.

After Plow Lines are Established

- Remove any material above the line that could carry fire across the control line such as vines and overhanging brush.
- Fall snags near line (inside and outside).
- Construct water bars and leadoff ditches in steeper terrain to prevent soil erosion.
- Seed and fertilize exposed soil on plow lines in steep topography to prevent soil erosion.

Burning-unit Map

- Locate all control lines on the map noting any changes from the original plan.
- Note on the map any danger spots along control lines having potential for fire escape.

Executing the Burn

There are few days of good prescribed burning weather during the year. When these days arrive, give top priority to burning. With adequate preparation, burning can begin without loss of opportunity.

A prescribed burning crew consisting of a burning boss and 3 to 6 crew members can handle a burn of several hundred acres. The leader should be an experienced prescribed burner with an understanding of fire behavior. Such a crew often consists of 3 torch people equipped with hand tools, and a tractor operator with a plow unit for emergency use. If aerial ignition is used, the ground crew often consists of a tractor-plow unit and a 2-person crew with 2 pickups. The aerial crew generally consists of a pilot and machine operator when the ping-pong ball system is used. If the pilot is not an experienced fire behavior observer, the burning boss should also be in the helicopter (as allowed) where he/she will have a relatively unobstructed view of the developing fire. Use of the helitorch can require 2 to 3 additional ground support people to mix the fuel and position the drums depending upon torch configuration and company/agency policy. Disposal of any unused helitorch fuel mix can present additional logistical problems; alumagel is toxic and should never just be dumped.

Radios for communication are essential for aerial ignition and for any large burn. Behavior of a prescribed burn will vary because of roads or other openings in the timber stand, varying fuel conditions, changing weather, and the firing technique used. Two vehicles are essential to permit maximum mobility of the burning boss and crews. Chain saws are useful additions to the equipment supply.

The burning boss should have the crew ready to fire the area as early in the day as conditions permit, leavin

maximum time for rnopup and patrol of the lines. Normally, plan to complete any one job within a standard workday. The burning boss must make sure the crew has the proper clothing and safety equipment and is in good physical shape. Proper clothing includes long-sleeve fire resistant or cotton shirts, pants without cuffs, leather boots with non-skid soles, safety glasses, hardhat, gloves, and plenty of drinking water. During the summer, the possibility of heat exhaustion and heat stroke must be considered.



Examples of prescribed burning equipment



Post smoke warning signs



Check fuel moisture of duff and litter

Checklist

- Make sure all equipment is in working order and safe to use.
- Carry burning plans and maps to the job.
- Check the weather before starting to burn and keep updated throughout the day.
- Check all control lines, clean out needles and leaves, and reinforce as necessary.
- Notify adjoining property owners and local fire control organizations before starting fire.

- Instruct crew on procedures, including safety precautions and the proper operation of equipment and use of hand tools.
- Post signs on public roads and be prepared to control traffic if potential exists for smoke to reduce visibility.
- Check duff and soil for dampness.
- Test burn with a small fire before firing; check the fire and smoke behavior to make sure the fire is burning as expected. If it is not, decide whether the observed behavior is acceptable. This is the time to

- cancel the burn if you are not comfortable with the observed behavior.
- Inform crew of starting point and firing sequence. Give each member a map.
 - Have a means of instant communication with all crew members. Portable radios are very useful.
 - Be alert to changing conditions, and be prepared to change burning techniques or plow the fire out if an emergency arises.
 - Burn so the wind will carry smoke away from sensitive areas.
 - Mopup and patrol perimeters constantly during the operation, and thereafter until there is no further danger of fire escape or smoke problems.



Small test fire to check behavior of fire and smoke

*"Give Prescribed Burning
TOP PRIORITY
When Burning Weather Arrives"*



Constantly monitor fire behavior



Prompt mopup will minimize residual smoke

Evaluating the Burn

The purposes of a burn evaluation are to determine how well the stated objectives of the burn were met and to gain information to be used in future burns. An initial evaluation should be made immediately after the burn, perhaps the following morning. A second evaluation should be made during or after the first postfire growing season.

Points to be Considered

- Was preburn preparation properly done?
- Were objectives met?
- Was burning plan adhered to? Were changes documented?
- Were weather conditions, fuel conditions, fire behavior, and smoke dispersion within planned limits?
- What were effects on soil, air, vegetation, water, and wildlife?
- Was fire confined to intended area; any escapes?
- Was burning technique correct?
- Were costs commensurate with benefits derived?
- How can similar burns be improved?

Indications and Guidelines

Needle Scorch

The best indicator of crop tree damage is percent foliage discoloration. Assuming that buds and branchlets are not heat-killed, even crown scorch approaching 100 percent generally will not kill trees unless secondary factors such as insect attack or drought materialize. If, however, loblolly pine stands are burned in the fall (September or October), after the trees have undergone their last needle flush of the growing season but prior to the onset of dormancy, research indicates that 100 percent crown scorch is likely to kill them. Slash pine appears to be more tolerant of severe crown scorch during the fall.

If more than 15 percent of a southern pine tree's needles are actually consumed by flames, the tree's chances of survival would be poor even if very little of the rest of the crown is scorched. Young vigorous trees are more likely to survive severe crown damage than are older individuals.

Magnitude and duration of growth responses in southern pines due to various levels and seasons of defoliation are not well documented. Both negative and positive responses have been observed, but the preponderance of evidence shows a direct relationship between diameter and height growth loss and crown scorch.

Providing no crown consumption took place, the following table will help in estimating potential growth loss in loblolly and slash pines over 3 inches dbh. These "ball park" estimates can be used for other southern pines as well, until more specific results become available.

A good indicator of hardwood control is a series of bark cracks extending into the cambium near ground level. This indicates sufficient heat was applied to penetrate the bark and kill the cambium. Although large hardwoods can be damaged by periodic fires they are difficult to kill.

Judge the success of burning for brownspot control by the number of longleaf seedlings with all infected

needles burned off, but still having a protective sheath of green needles around the unharmed terminal bud.

Soil and Root Damage

Burning under prescribed conditions in the South generally does not expose bare soil. If duff remains after a burn, the physical properties of the soil probably were not harmed. If mineral soil is exposed, especially on steep slopes, soil movement and deterioration of site quality may occur.

Root damage is likely whenever the organic layer is completely consumed. It should also be expected whenever burns are conducted over dry soils (drought conditions) or when a deep litter layer is present, even though some duff remains. New root growth in vigorously growing pines can usually offset these losses, but older trees, having survived such fires without crown damage, often die six months to a year later for no apparent reason.

Air Quality

Smoke behavior must be continually evaluated from the time the fire is ignited until smoldering ceases. Unusual or unexpected smoke effects should be noted and correlated with other parameters of the burn for future use. Any public complaints should be recorded as part of the evaluation.

Percent Crown Scorch	Damage
0 to 33	Some volume growth loss may occur the first postfire growing season but it will be minor.
34 to 66	Volume growth loss usually less than 40 percent and confined to first postfire growing season.
67 to 100	Reduction may be as high as a full year's volume growth spread over 3 years.

Timing and Points to Evaluate

Evaluation should take place immediately after the burn and again during the first post-burn growing season. In the case of late summer prescribed burns, the second evaluation should take place the following spring after the next growing season has begun.

Points in First Evaluation

- Amount of overstory foliage discoloration.
- Amount of consumption and top-kill of understory vegetation.
- Consumption of infected needles on longleaf seedlings without injury to terminal bud.
- Amount of litter remaining on forest floor.
- Smoke dispersion into upper atmosphere and success in avoiding smoke-sensitive areas.
- Protection of areas not to be burned.
- Any escape of fire.
- Any adverse public comment or reaction prior to, during, or immediately after the burn.

Points in Future Evaluation

Future evaluation can best be made after the start of the growing season to determine the following:

- Resin exuding from pine trees, an indicator of cambium damage or insect attack.
- Other signs of beetle attack.
- Mortality of timber or other desirable vegetation.
- Sprouting vigor of undesired vegetation.
- Recovery of longleaf seedlings free of brownspot.
- Remaining duff layer, mineral soil exposed, and any soil movement.
- Public expression for or against the burning program.



Evaluating a prescribed burn

Coordination of Burning

These guidelines are general and will not fit all situations.

	PURPOSE	TIME OF BURN	SIZE OF BURN	TYPE OF FIRE	FREQUENCY	REMARKS
	REDUCE FUELS	Winter	Large enough to break fuel continuity	Not critical. Do not ring fire.	2 to 4 years	Use line-backing fire, or point-source fires under moist conditions for initial burn. Grid-firing technique excellent for maintenance burns.
IMPROVE WILDLIFE HABITAT						General — Protect transitional or fringe areas. Do not burn stream bottoms.
Deer		Winter preferred	Small or leave unburned areas	Backing fire or point-source fires	2 to 4 years	Want to promote sprouting and keep browse within reach. Repeat summer fires may kill some rootstocks.
Turkey		Winter preferred; summer burns in July - August	Small or leave unburned areas	Backing fire or point-source fires	2 to 4 years	Avoid April through June nesting season.
Quail		Late winter	25+ acres	Not critical. Do not ring fire	1 to 2 years	Avoid April through June nesting season. Leave unburned patches and thickets.
Dove		Winter	Not critical	Not critical. Do not ring fire	Not critical	Leave unburned patches and thickets.
Waterfowl		Late fall or winter	Not critical	Heading fire	2+ years	Marshland only. Do not burn in hardwood swamps.
CONTROL COMPETING VEGETATION		Heavy roughs in winter, otherwise not critical	Not critical.	Not critical. Do not ring fire.	2 to 8 years	Summer burns result in higher rootstock kill and affect larger stems. Exclude fire from desirable hardwoods in pine-hardwood type.
IMPROVE FORAGE FOR GRAZING		Winter through late spring for most situations	Not critical but will be damaged by overuse if too small for herd.	Not critical. Do not ring fire.	3 years	Split range and burn one-third each year. Individual herbs and grasses respond differently to fire and season of burn. Consult expert.
IMPROVE ACCESSIBILITY		Will vary with understory and desired use	Varies with individual situation	Depends on amount of fuel present	As needed	Coordinate with other resource objectives. They will dictate size, timing and frequency of burn.
CONTROL DISEASE		Brownspot, winter	Depends on size of infected area. Include a buffer strip	Strip-heading or heading fire	2 to 3 years	Burn when humidity is above 500/0. Avoid leaving unburned pockets of infected seedlings within or adjacent to burn.

<i>PURPOSE</i>	<i>TIME OF BURN</i>	<i>SIZE OF BURN</i>	<i>TYPE OF FIRE</i>	<i>FREQUENCY</i>	<i>REMARKS</i>
ENHANCE APPEARANCE	Late fall through late winter	Varies with each situation	Backing fire or point-source fire	1 + years	Requires precise prescription to protect vegetative type changes. Know effect of fire frequency and season of burn on both annual and biennial flowering plants. Provide pleasing visual lines.
PERPETUATE FIRE DEPENDENT SPECIES	Will vary with species	Will vary but usually fairly small	Will vary with fuel conditions and species requirements.	Will vary with species	Fire intensity, timing and frequency all dictated by species requirements.
YOUNG PINE STANDS	Winter	Varies with size of stand	Backing fire	2 to 4 years	Pine diameter 3 inches or more at ground. Pine height above 10 ft. Burn only after a strong cold front with rain.
DISPOSE OF LOGGING DEBRIS	Not critical	Small areas mean fewer nighttime smoke problems	Center firing with helitorch preferred	— —	Smoke management is a must! Take care not to damage soil or water resources with these hot fires. If a broadcast burn will not meet objectives, pile - do not wind-row debris.
PREPARE SITES FOR SEEDING	Natural seeding, summer to early fall prior to seed fall.	Large enough to prevent concentrations of birds & rodents (usually 10 acres or more).	Not critical. Do not ring fire	— —	Be careful not to kill seed trees. If logging debris present, manage your smoke.
	Direct seeding, fall to late winter for spring sowing. Previous winter for fall sowing of longleaf.	Large enough to prevent concentrations of birds & rodents (usually 10 acres or more).	Not critical. Center firing with helitorch preferred if slash present.		If logging debris present, smoke management is a must! Take care not to damage soil or water resources with these hot fires
PREPARE SITES FOR PLANTING	Growing season for hardwood control.	Large enough to prevent concentrations of birds & rodents (usually 10 acres or more).	Not critical. Center firing with helitorch preferred if slash present.	— —	If logging debris present, smoke management is a must! Take care not to damage soil or water resources with these hot fires

Rules of Thumb

1. Obtain and use latest weather and smoke management forecasts.
2. Relative humidity will roughly halve with each 20°F rise in temperature and double with each 20°F drop in temperature in a given air mass.
3. Expect increased spotting when relative humidity drops below 30 percent. Do not burn when the relative humidity is below 25 percent.
4. Burn when mixing height is above 1,650 feet [500 meters].
5. Do **not** burn under temperature inversions.
6. Burn areas with low fuel loadings and large-sized trees on marginal days at the high end of the prescription window.
7. Never underburn during a drought. Soil moisture is needed to protect tree roots and lower litter.
8. Don't burn on organic soils unless the water table is very close to the surface.
9. Heading fires produce about three times more particulate than backing fires.
10. Burn when fuels are dry, but not too dry. Wet fuels produce substantially more particulate than do dry fuels.
11. Start burning logging debris by midmorning.
12. Site prep burning behind chopping or other mechanical treatment gives best results if done 10 to 15 days after treatment.
13. Windrows are the most polluting of all southern fuel types.
14. Broadcast burn scattered debris if possible.
15. Do not pile when either ground or debris is wet.
16. Dirt in piled debris will increase the amount of smoke produced by up to four times. Shake out dirt while piling "bump" piles while burning, and repile as necessary.
17. Use a smoke management plan. Consider smoke sensitive areas. Look several miles downwind and down-drainage for potential targets.
18. Estimate background smoke concentration [micrograms per cubic meter] in the absence of high humidities by dividing 500 by the visibility in miles.
19. If nighttime Dispersion Index forecast is poor or very poor [less than 13], stop burning by 3 p.m. ST.
20. Doubling the Dispersion Index implies a doubling of the atmospheric capacity to disperse smoke within a 1,000 square mile area.
21. Assuming 1 ton of fuel per acre is being consumed by smoldering combustion during poor nighttime dispersion conditions, expect visibility in the smoke to be less than 1/2 mile within 1 1/2 miles of the fire.

Red Flag Situations

If any of the following conditions exist, analyze further before burning.

Underburning:

- No written plan
- No map
- No safety briefing
- Heavy fuels
- Dry duff and soil
- Extended drought
- Inadequate control lines
- No updated weather forecast for area
- Forecast does not agree with prescription
- Poor visibility
- Personnel or equipment stretched thin
- Burning large area using ground ignition
- Communications for all people not available
- No backup plan or forces available
- No one notified of plans to burn

- Behavior of test fire not as prescribed
- A smoke-management system has not been used
- Smoke-sensitive area downwind or down drainage
- Organic soil present
- Daytime Dispersion Index below 40
- Not enough personnel or equipment available to control an escaped fire
- Personnel on fire not qualified to take action on escaped fire.

Debris burning - in addition to the above:

- Area contains windrows
- A lot of dirt in piles
- Poor nighttime smoke dispersion forecast
- Have not looked down drainage
- Mixing height is below 1,650 feet (500 meters)
- Debris was piled when wet
- Pile exteriors are wet

If any of the following conditions exist, stop burning and plow out existing fire.

- Fire behavior erratic
- Spot fire or slop-over occurs and is difficult to control
- Wind shifting or other unforeseen change in weather
- Smoke not dispersing as predicted
- Public road or other sensitive area smoked in
- Burn does not comply with all laws, regulations, and standards
- Large fuels igniting and burning, not enough personnel to mopup before dark and likely to smoke in a smoke sensitive area

Glossary

Aerial Fuels—Standing and supported live and dead forest combustibles not in direct contact with the ground consisting mainly of foliage, twigs, branches, cones, bark, stems, and vines (See Draped Fuels, Ladder Fuels).

Aerial Ignition—Ignition of fuels by dropping incendiary devices or materials from aircraft.

Age of Rough—Time in years since the forest floor was last reduced by fire.

Air Stagnation Advisory (ASA) — A statement issued by a National Weather Service office when atmospheric conditions are stable enough that the *potential* exists for pollutants to accumulate in a given area.

Anemometer—General name for instruments designed to measure windspeed.

Area Ignition—Igniting, throughout an area to be burned, a number of individual fires either simultaneously or in rapid succession and so spaced that they soon influence and support each other to produce a hot, fast-spreading fire throughout the area.

Aspect—Direction toward which a slope faces.

Atmospheric Stability—A measure of the degree to which the atmosphere resists turbulence and vertical motion. In prescribed fire activities the atmosphere is usually described as stable, neutral, or unstable.

Available Fuel—That portion of the total fuel that would actually be consumed under a specific set of burning conditions.

Backing Fire—A fire spreading or set to spread into (against) the wind, or downhill. (See Flanking Fire, Heading Fire).

BEHAVE —A system of interactive computer programs for modeling fuel and fire behavior comprised of two subsystems: BURN and FUEL.

Belt Weather Kit—Belt mounted canvas case with fitted pockets for anemometer, compass, sling psychrometer, slide rule, water bottle, pencils, and book of weather report forms.

Blackline—Preburning of fuels, either adjacent to a control line before igniting the main prescribed fire, or along a roadway as a deterrent to human-caused fires. Blackline denotes a condition in which there is no unburned fine fuel.

Broadcast Burn—Prescribed fire that burns over a designated area, generally in the absence of a merchantable overstory, to consume debris that has not been piled or windrowed.

Brown & Burn—Application of herbicide to desiccate living vegetation prior to burning.

Brownspot Control—A prescribed burn to control a fungal infection (brownspot disease) of longleaf pine in the "grass" (small seedling) stage.

Buildup—Cumulative effects of long-term drying on current fire danger.

Buildup Index (BUI)—A relative number expressing the cumulative effect of daily drying factors and precipitation on fuels with a 10-day timelag constant.

Burning Boss—Person responsible for managing a prescribed fire from ignition through mopup.

Burning Index (BI)—A relative number related to the contribution fire behavior makes to the amount of effort needed to contain a fire within a given fuel type. A doubling of the BI indicates twice the effort will be needed to contain a fire in that fuel type as was previously required.

Category Day—A numerical index related to the ability of the atmosphere to disperse smoke. For example, in South Carolina the current scale, based on Ventilation Factor, ranges from 1 (poor) to 5 (excellent).

Catface—Defect on the surface of a tree resulting from a wound where healing has not re-established the normal cross-section.

Center Firing—A method of broadcast burning in which fire(s) are set in the center of the area to create a convection column with strong surface indrafts. Usually additional fires are then set progressively nearer the outer control lines as the indraft builds up, to draw the flames and smoke toward the center of the burn.

Chain —Unit of measure in land survey equal to 66 feet; 80 chains equal 1 mile.

Clearcutting—Removal of the entire standing, merchantable timber crop.

Cold Front—The leading edge of a mass of air that is colder and drier than the air mass being replaced.

Control Line—Comprehensive term for all constructed or natural fire barriers and treated fire edges used to control a fire.

Convection Column—The rising column of gases, smoke and debris produced by a fire. The column has a strong vertical component indicating that buoyant forces override the ambient surface wind (See Smoke Plume).

Convergence Zone—The area of increased flame heights and fire intensity produced when two or more flame fronts burn together.

Crown Scorch—Browning of needles or leaves in the crown of a tree or shrub caused by heat from a fire.

Cured—Debris or herbaceous vegetation that has dried and lost its green color.

DAID (Delayed Aerial Ignition Device)— See Ping-pong Ball System.

Debris Burning—In this publication, defined as any prescribed fire used to dispose of scattered, piled, or windrowed dead woody fuel in the absence of an overstory. Such a burn often accomplishes the objectives of a Site Prep Burn as well.

Dew Point—Temperature to which air must be cooled to reach saturation at a constant atmospheric pressure. The dew point is always lower than the wet-bulb temperature, which in turn is always lower than the dry-bulb temperature. The only exception to this is when the air is saturated (i.e., relative humidity is 100 percent), in which case all three values are equal.

Dispersion—The decrease in concentration of airborne pollutants as they spread throughout an increasing volume of atmosphere.

Dispersion Index—As used in this manual, a numerical index developed by Lee Lavdas (Southern Forest Fire Laboratory). This index is an estimate of the atmosphere's capacity to disperse smoke from prescribed burns over a 1,000-square-mile area. It is related to the Ventilation Factor, but also considers the rate of pollutant dispersion.

Draped Fuels—Needles, leaves, twigs, etc., that have fallen from above and have lodged on lower branches and brush. Part of aerial fuels.

Drift Smoke—Smoke that has been transported from its point of origin and in which convective motion no longer dominates.

Drip Torch—Hand-held apparatus used to ignite fires by dripping flaming liquid fuel, at an adjustable rate, on the materials to be burned. The fuel is generally a mixture of 65 to 80 percent diesel and 20 to 35 percent gasoline.

Drought Index (Keetch-Byram Drought Index)—A numerical rating of the net effect of evapotranspiration and precipitation in producing cumulative moisture depletion in deep duff or upper soil layers.

Dry-bulb Temperature—The temperature of the air.

Duff—The layer of decomposing organic materials lying below the litter layer and immediately above the mineral soil. It is comprised of the Fermentation (F) and Humus (H) layers of the forest floor.

Edge—As used in this manual, the boundary between two fairly distinct fuel types.

Emission Factor—The amount of pollution (pounds per ton) released to the atmosphere per unit weight of dry fuel consumed during combustion.

Emission Rate—The quantity of pollutant released to the atmosphere per unit length of fire front per unit time.

Equilibrium Moisture Content (EMC)—The moisture content that a fuel would eventually attain if exposed for an infinite period to specified constant values of Dry-bulb Temperature and Relative Humidity.

Fine Fuels (Flash fuels) — Fast-drying, dead fuels which have a Timelag constant of 1 hour or less. These fuels ignite readily and are consumed rapidly when dry. Included are grass, leaves, draped pine needles, and small twigs.

Fire Behavior—A general term that refers to the combined effect of fuel, weather and topography on a fire.

Firebrand—Any flaming or smoldering material such as leaves, pine cones, or glowing charcoal that could start another fire.

Firebreak—Any natural or constructed discontinuity in a fuelbed used to segregate, stop, or control the spread of fire or to provide a control line from which to suppress a fire.

Fire Effects—Physical, biological and ecological impacts of fire on the environment.

Fire Front—The strip within which continuous flaming occurs along the fire perimeter (See Flame Depth).

Fireline Intensity (Byram's Intensity)—The rate of heat release per unit time per unit length of fire front. Numerically, it is the product of the heat yield, the quantity of fuel consumed in the Fire Front, and the rate of spread.

Fire Plow—Heavy-duty share or disk plow designed to be pulled by a tractor to construct Firebreaks.

Fire Rake—A long-handled combination rake and cutting tool, the blade of which is usually constructed of a single row of 4 sharpened teeth.

Firing Technique—The type(s) of fire resulting from one or more ignition(s), e.g., backing fire, flanking fire, heading fire, (See Grid Ignition, Ignition Pattern).

Flame Depth—The depth of the Fire Front at the fuel surface.

Flame Length—The distance between the flame tip and the midpoint of the Flame Depth at the base of the flame (generally at the ground surface).

Flanking Fire—A Fire Front spreading, or set to spread at roughly right angles to the prevailing wind.

Flash Fuels—See Fine Fuels.

Flying Drip Torch—See Helitorch.

Fuel Moisture Content—Water content of a fuel expressed as a percentage of the oven-dry weight of the fuel.

Fuel Moisture Indicator Sticks—A specially manufactured set of sticks of known dry weight continuously exposed to the weather and periodically weighed to determine changes in moisture content. The changes are an indication of changes in the moisture status and relative flammability of dead fuels that roughly correspond to Ten-hour Timelag Fuels.

Grid Ignitions—Method of igniting fires in which ignition points are set individually at predetermined spacing with predetermined timing throughout the area to be burned (see Ping-pong Ball System).

Dew Point—Temperature to which air must be cooled to reach saturation at a constant atmospheric pressure. The dew point is always lower than the wet-bulb temperature, which in turn is always lower than the dry-bulb temperature. The only exception to this is when the air is saturated (i.e., relative humidity is 100 percent), in which case all three values are equal.

Dispersion—The decrease in concentration of airborne pollutants as they spread throughout an increasing volume of atmosphere.

Dispersion Index—As used in this manual, a numerical index developed by Lee Lavdas (Southern Forest Fire Laboratory). This index is an estimate of the atmosphere's capacity to disperse smoke from prescribed burns over a 1,000-square-mile area. It is related to the Ventilation Factor, but also considers the rate of pollutant dispersion.

Draped Fuels—Needles, leaves, twigs, etc., that have fallen from above and have lodged on lower branches and brush. Part of aerial fuels.

Drift Smoke—Smoke that has been transported from its point of origin and in which convective motion no longer dominates.

Drip Torch—Hand-held apparatus used to ignite fires by dripping flaming liquid fuel, at an adjustable rate, on the materials to be burned. The fuel is generally a mixture of 65 to 80 percent diesel and 20 to 35 percent gasoline.

Drought Index (Keetch-Byram Drought Index)—A numerical rating of the net effect of evapotranspiration and precipitation in producing cumulative moisture depletion in deep duff or upper soil layers.

Dry-bulb Temperature—The temperature of the air.

Duff—The layer of decomposing organic materials lying below the litter layer and immediately above the mineral soil. It is comprised of the Fermentation (F) and Humus (H) layers of the forest floor.

Edge—As used in this manual, the boundary between two fairly distinct fuel types.

Emission Factor—The amount of pollution (pounds per ton) released to the atmosphere per unit weight of dry fuel consumed during combustion.

Emission Rate—The quantity of pollutant released to the atmosphere per unit length of fire front per unit time.

Equilibrium Moisture Content (EMC)—The moisture content that a fuel would eventually attain if exposed for an infinite period to specified constant values of Dry-bulb Temperature and Relative Humidity.

Fine Fuels (Flash fuels) — Fast-drying, dead fuels which have a Timelag constant of 1 hour or less. These fuels ignite readily and are consumed rapidly when dry. Included are grass, leaves, draped pine needles, and small twigs.

Fire Behavior—A general term that refers to the combined effect of fuel, weather and topography on a fire.

Firebrand—Any flaming or smoldering material such as leaves, pine cones, or glowing charcoal that could start another fire.

Firebreak—Any natural or constructed discontinuity in a fuelbed used to segregate, stop, or control the spread of fire or to provide a control line from which to suppress a fire.

Fire Effects—Physical, biological and ecological impacts of fire on the environment.

Fire Front—The strip within which continuous flaming occurs along the fire perimeter (See Flame Depth).

Fireline Intensity (Byram's Intensity)— The rate of heat release per unit time per unit length of fire front. Numerically, it is the product of the heat yield, the quantity of fuel consumed in the Fire Front, and the rate of spread.

Fire Plow—Heavy-duty share or disk plow designed to be pulled by a tractor to construct Firebreaks.

Fire Rake—A long-handled combination rake and cutting tool, the blade of which is usually constructed of a single row of 4 sharpened teeth.

Firing Technique—The type(s) of fire resulting from one or more ignition(s), e.g., backing fire, Clanking fire, heading fire. (See Grid Ignition, Ignition Pattern).

Flame Depth —The depth of the Fire Front at the fuel surface.

Flame Length—The distance between the flame tip and the midpoint of the Flame Depth at the base of the flame (generally at the ground surface).

Flanking Fire—A Fire Front spreading, or set to spread at roughly right angles to the prevailing wind.

Flash Fuels—See Fine Fuels.

Flying Drip Torch—See Helitorch.

Fuel Moisture Content—Water content of a fuel expressed as a percentage of the oven-dry weight of the fuel.

Fuel Moisture Indicator Sticks—A specially manufactured set of sticks of known dry weight continuously exposed to the weather and periodically weighed to determine changes in moisture content. The changes are an indication of changes in the moisture status and relative flammability of dead fuels that roughly correspond to Ten-hour Timelag Fuels.

Grid Ignitions—Method of igniting fires in which ignition points are set individually at predetermined spacing with predetermined timing throughout the area to be burned (see Ping-pong Ball System).

Hazard Reduction—Treatment of living and dead forest fuels to reduce the likelihood of a fire starting, and to lessen its damage potential and resistance to control.

Heading Fire—A Fire Front spreading or set to spread with the wind or upslope.

Helitorch (Flying Drip Torch)—A specialized drip torch hung from, or mounted on a helicopter that dispenses globs of ignited gelled gasoline.

Herbaceous Fuels—Grasses and other plants that contain little woody tissue.

Humus—The layer of decomposed organic matter on the forest floor beneath the partially decomposed litter layer (F layer) and directly above the soil.

Hygrothermograph—An instrument that continuously records Dry-bulb Temperature and Relative Humidity.

Ignition Pattern—The manner in which a Prescribed Fire is ignited. The distance between ignition lines or points and the sequence of igniting them, as determined by fuel, topography, weather, ignition system, firing technique, and other factors influencing fire behavior and the objectives of the burn (See Firing Technique).

In-stand Wind (Midflame Wind)—Windspeed within a stand at about eye level.

Inversion—In this publication, defined as a layer of the atmosphere through which the temperature increases with increasing height.

Keetch-Byram Drought Index—See Drought Index.

Ladder Fuels—Fuels that provide vertical continuity between the ground and tree crowns, thus creating a pathway for a surface fire to move into the overstory tree crowns.

Line Ignition—Setting a line of fire as opposed to individual spots.

Litter—The top layer (L layer) of the forest floor directly above the fermentation layer (F layer), composed mainly of recently fallen leaves and pine needles, but also includes dead twigs, bark fragments, etc. (See Duff).

Logging Debris—Unwanted tree parts remaining after harvest, including tree crowns, unutilized logs, and uprooted stumps.

Low-Level Jet—See Wind Profile.

Midflame Wind—See In-stand wind.

Mineral Soil—Soil layers below the predominantly organic horizons.

Mixing Height—The height to which relatively vigorous mixing of the atmosphere occurs.

Mopup—Extinguishing or removing burning material, especially near control lines after an area has burned to make it safe, or to reduce residual smoke.

Muck—See Organic Soil.

National Fire Danger Rating System (NFDRS)—The method currently used by the USDA Forest Service, and many other organizations to integrate the effects of topography, fuels, and weather into numerical indices of fire danger on a day-to-day basis.

One-Hour Timelag Fuels—Fine fuels consisting mainly of dead herbaceous plants, roundwood less than about 1/4-inch in diameter, and the uppermost Litter Layer.

Organic Soil—Any soil or soil horizon containing at least 30 percent organic matter; examples are peat and muck.

Particulate (Total Suspended Particulate (TSP))—Any liquid or solid particles temporarily suspended in the atmosphere. See PM-10.

Peat—See Organic Soil.

Ping-pong Ball System—A method of igniting fires with the use of a Delayed Aerial Ignition Device (DAID). The device is a polystyrene ball, 1.25 inches in diameter that contains a combustible chemical. The balls are fed into a dispenser, generally mounted in a helicopter, where they are injected with another chemical and drop through a chute leading out of the helicopter. The chemicals react thermally and ignite in about 30 seconds. The space between ignition points on the ground is primarily a function of helicopter speed, gear ratio of the dispenser, and the number of chutes used (up to 4) (See Grid Ignition).

PM-10—Particulate with an aerodynamic diameter smaller than or equal to 10 micrometers.

Prescribed Burning—The controlled application of fire to wildland fuels in either a natural or modified state, under specified environmental conditions which allow the fire to be confined to a predetermined area and at the same time produce the intensity required to attain planned resource management objectives.

Psychrometer—The general name for instruments designed to determine the moisture content of air. A psychrometer consists of dry-and wet-bulb thermometers that give the Dry-and Wet-bulb Temperatures, which in turn are used to determine Relative Humidity and Dew Point.

Relative Humidity—The ratio, expressed as a percentage of the amount of moisture in the air, to the maximum amount of moisture the air is capable of holding under the same conditions.

Residence Time—The time (seconds) required for the Fire Front to pass a stationary point at the surface of the fuel. Numerically, it is the Flame Depth divided by the rate of spread.

Residual Smoke—Smoke produced by smoldering material behind the actively burning Fire Front.

Ring Fire—A fire started by igniting the perimeter of the intended burn area so that the ensuing Fire Fronts converge toward the center of the block.

Rough—The live understory and dead fuels that build up on the forest floor over time.

Scorch Height (Scorch Line)—The average height to which foliage has been browned by fire.

Site Prep Burn—A fire set to expose adequate mineral soil and control competing vegetation until seedlings of the desired species become established (See Debris Burning).

Slash—Debris resulting from such natural events as wind, fire, or snow breakage, or such human activities as logging or road construction.

Smoke Concentration—The weight of combustion products (micrograms per cubic meter) found in a given volume of air.

Smoke Management—Application of knowledge of fire behavior and meteorological processes to minimize air quality degradation during Prescribed Burning.

Smoke Plume—The gases, smoke, and debris that rise slowly from a fire while being carried along the ground because the buoyant forces are exceeded by those of the ambient surface wind (See Convection Column).

Smoke-sensitive Area (SSA)—An area in which smoke from outside sources is intolerable.

Smoldering Combustion Phase—Combustion associated with residual burning of forest fuels behind the Fire Front. Emissions are at least twice that of the Fire Front, and consist mainly of tars.

Spot Fire—Fire ignited outside the perimeter of the main fire by a Fire Brand.

Spot Weather Forecast—Special prediction of atmospheric conditions at a specific site, sometimes requested by the Burning Boss before igniting a prescribed fire.

Stagnant Conditions—Conditions under which pollutants build up faster than the atmosphere can disperse them.

Strip-Heading Fire—A series of lines of fire upwind (or downslope) of a firebreak or backing fire that will burn with the wind toward the firebreak or backing fire.

Ten-Hour Time lag Fuels—Dead roundwood 1/4 to 1 inch in diameter and, to a rough approximation, the top 3/4 inch of the litter layer.

Timelag—The drying time, under specified conditions, required for a dead fuel to lose about 63 percent of the difference between its initial moisture content and its Equilibrium Moisture Content. Providing conditions remain unchanged, a fuel will reach 95 percent of its EMC after four timelag periods.

Tractor-Plow—Any tracked vehicle, with a plow for exposing mineral soil, with transportation and personnel for its operation.

Transport Windspeed—A measure of the average rate of the horizontal movement of air throughout the mixing layer.

Underburning—Prescribed burning under a timber canopy.

Ventilation Factor—An indicator of the lower atmosphere's potential to diffuse and disperse smoke. Numerically, it is the product of the Mixing Height and the Transport Windspeed (See Dispersion Index).

Wet-bulb Temperature—Technically, the temperature registered by the wet-bulb thermometer of a Psychrometer. It is the lowest temperature to which air can be cooled by evaporating water into it at a constant atmospheric pressure.

Wet line—A line of water, or water and chemical retardant, sprayed along the ground and which serves as a temporary control line from which to ignite or stop a low-intensity fire.

Wind Direction—Compass direction from which the wind is blowing.

Wind Profile—A plot of windspeed over height above the earth's surface. A rapid increase with height to a maximum windspeed within 1,000 feet above ground and then a slow decrease above that peak is commonly called a low-level jet and is one of several adverse wind profiles.

Windrow—Woody debris that has been piled into a long continuous row.

Suggested Reading

Abercrombie, James A., Jr; Sims, Daniel H. 1986. Fell and burn for low-cost site preparation. *Forest Farmer*. 46(1): 14-17.

Andrews, Patricia L. 1986. BEHAVE: Fire behavior prediction and fuel modeling system-burn subsystem, part 1. *Gen Tech. Rep. INT-194*. Ogden, UT: U.S. Department of Agriculture, Forest Service, Intermountain Forest and Range Experiment Station. 130 p.

Boyer, William D. 1987. Volume growth loss: a hidden cost of periodic prescribed burning in longleaf pine. *Southern Journal of Applied Forestry*. 11(3): 154-157.

Brown, A.A.; Davis, K.P. 1973. *Forest fire: control and use*. 2d ed. New York: McGraw-Hill. 584 p.

Burgan, Robert E.; Rothermel, Richard C. 1984. BEHAVE: Fire behavior prediction and fuel modeling system - fuel subsystem. *Gen. Tech. Rep. INT-167*. Ogden, UT: U.S. Department of Agriculture, Forest Service, Intermountain Forest and Range Experiment Station. 126 p.

Byram, George M. 1954. Atmospheric conditions related to blowup fires. *Station Pap.* 35. Asheville, NC: U.S. Department of Agriculture, Forest Service, Southeastern Forest Experiment Station. 34 p.

Countryman, Clive M. 1971. This humidity business: what's it all about and its use in fire control? Berkeley, CA: U.S. Department of Agriculture, Forest Service, Pacific Southwest Forest and Range Experiment Station. 15 p.

Crocker, Thomas C., Jr. 1967. Crop-seedling method for planning brown-spot burns in longleaf pine. *Journal of Forestry*. 65(7): 488.

Golden, Michael S. 1987. Development and evaluation of low-cost systems for artificial regeneration of pine. *Ga. For. Res. Pap.* 71. Macon, GA: Georgia Forestry Commission. 12 p.

Grano, Charles X. 1970. Eradicating understory hardwoods by repeated prescribed burning. *Res. Pap. SO-56*. New Orleans, LA: U.S. Department of Agriculture, Forest Service, Southern Forest Experiment Station. 11 p.

Greene, Thomas A.; Shilling, Charles L. 1987. Predicting girdling probability for pine and hardwood saplings in low-intensity backfires. *Forest Science*. 33(4): 1010-1021.

Hough, W.A. 1968. Fuel consumption and fire behavior of hazard reduction burns. *Res. Pap. SE-36*. Asheville, NC: U.S. Department of Agriculture, Forest Service, Southeastern Forest Experiment Station. 7 p.

Hough, W.A.; Albini, F.A. 1978. Predicting fire behavior in palmetto-gallberry fuel complexes. *Res. Pap. SE-174*. Asheville, NC: U.S. Department of Agriculture, Forest Service, Southeastern Forest Experiment Station. 44 p.

Hughes, Ralph. 1975. The native vegetation in south Florida related to month of burning. *Res. Note. SE-222*. Asheville, NC: U.S. Department of Agriculture, Forest Service, Southeastern Forest Experiment Station. 8 p.

Johansen, R.W. 1968. Fire control considerations in pine plantations. In: *Proceedings seventh forestry forum*; 1968 June 12-13; Auburn, Auburn University, AL: 14-19.

Johansen, Ragnar W. 1981. Windrows vs. small piles for forest debris disposal. *Fire Management Notes*. 42(2): 7-9.

Johansen, R.W. 1984. Prescribed burning with spot fires in the Georgia Coastal Plain. *Ga. For. Res. Pap.* 49. Macon, GA: Georgia Forestry Commission. 7 p.

Johansen, R.W. 1985. Is aerial ignition a panacea to the southern prescribed burner? In: *Shoulders, Eugene, ed. Proc. 3rd biennial southern silvicultural research conference*; 1984 November 7-8; Atlanta, GA. *Gen. Tech. Rep. SO-54*. New Orleans: U.S. Department of Agriculture, Forest Service, Southern Forest Experiment Station: 514-518.

Johansen, Ragnar W. 1987. Ignition patterns & prescribed fire behavior in southern pine stands. *Ga. For. Res. Pap.* 72. Macon, GA: Georgia Forestry Commission. 6 p.

Johansen, Ragnar W.; McNab, W. Henry 1977. Estimating logging residue weights from standing slash pine for prescribed burns. *Southern Journal of Applied Forestry*. 1(2): 2-6.

Johansen, R.W.; Wade, D.D. 1987. An insight into thinning young slash pine stands with tire. In: *Proceedings of the fourth biennial southern silvicultural research conference*; 1986 November 4-6; Atlanta, GA. *Gen. Tech. Rep. SE-42*. Asheville, NC: U.S. Department of Agriculture, Forest Service, Southeastern Forest Experiment Station. 103-106.

Johansen, Ragnar W.; Wade, Dale D. 1987. Effects of crown scorch on survival and diameter growth of slash pines. *Southern Journal of Applied Forestry*. 11(4): 180-184.

Johnson, Von J. 1984. Estimating moisture content in litter. *Southern Journal of Applied Forestry*. 8(4): 197-201.

- Lavdas, Leonidas G.** 1986. An atmospheric dispersion index for prescribed burning. Res. Pap. SE-256. Asheville, NC: U.S. Department of Agriculture, Forest Service, Southeastern Forest Experiment Station. 33 p.
- Lewis, Clifford E.; Harshbarger, Thomas J.** 1986. Burning and grazing effects on bobwhite foods in the southeastern Coastal Plain. *Wildlife Society Bulletin*. 14(4): 455-459.
- Lilieholm, Robert J.; Hu, Shih-Chang.** 1987. Effect of crown scorch on mortality and diameter growth of 19-year-old-loblolly pine. *Southern Journal of Applied Forestry*. 11(4): 209-211.
- Lotan, James E. (and others).** 1981. Effects of fire on flora: a state of knowledge review. Gen. Tech. Rep. WO-16. Washington: U.S. Department of Agriculture, Forest Service. 71 p.
- Lansford, James.** 1987. Prescribed fire in the Southeast-five steps to a successful burn. *Fire Management Notes*. 48(3): 30-35.
- Lyon, L. Jack (and others).** 1978. Effects of fire on fauna: a state of knowledge review. Gen. Tech. Rep. WO-6. Washington: U.S. Department of Agriculture, Forest Service, 22 p.
- Martin, Robert E. (and others).** 1979. Effects of fire on fuels; a state of knowledge review. Gen. Tech. Pap. WO-13. Washington: U.S. Department of Agriculture, Forest Service, 64 p.
- McKevin, Martha R.; McKee, William H., Jr.** 1986. Long-term prescribed burning increases nutrient uptake and growth of loblolly pine seedlings. *Forest Ecology and Management*. 17(4): 245-252.
- McMinn, James W. (and others).** 1987. Pre-harvest estimation of logging residues in middle Georgia. Ga. For. Res. Pap. 73. Macon, GA: Georgia Forestry Commission. 6 p.
- McNab, W. Henry.** 1976. Prescribed burning and direct-seeding old clearcuts in the Piedmont. Res. Note SE-229. Asheville, NC: U.S. Department of Agriculture, Forest Service, Southeastern Forest Experiment Station. 4 p.
- McPherson, Guy R.; Rasmussen, G. Allen; Wright, Henry A.; Britton, Carlton M.** 1986. Getting started in prescribed burning. Management Note 9. Lubbock: Texas Tech University, Texas Tech Range and Wildlife Manage. Dept. 5 p.
- Mobley, Hugh E.; Kerr, Ed.** 1973. Wildfire versus prescribed fire in the southern environment. Atlanta: U.S. Department of Agriculture, Southeastern Area, State and Private Forestry. 6 p.
- Paul, James T.; Lavdas, Leonidas G.; Wells, Wesley.** 1987. Use of general weather and Dispersion Index to minimize the impact of smoke on highway visibility. Ga. Forest Res. Pap. 69. Macon, GA: Georgia Forestry Commission. 10 p.
- Prescribed Fire and Fire Effects Working Team, National Wildfire Coordinating Group.** 1985. Prescribed fire smoke management guide. Publication 420-1. NFES No. 1279. Boise, ID: Boise Interagency Fire Center. 28 p.
- Rothermel, Richard. 1983. How to predict the spread and intensity of forest and range fires. Gen Tech. Rep. INT-143. Ogden, UT: U.S. Department of Agriculture, Forest Service, Intermountain Forest and Range Experiment Station. 161 p.
- Sackett, Steven S. 1975. Scheduling prescribed burns for hazard reduction in the Southeast. *Journal of Forestry*. 73(3): 143-147.
- Sandberg, D.V. (and others).** 1979. Effects of fire on air: a state of knowledge review. Gen. Tech. Rep. WO-9. Washington: U.S. Department of Agriculture, Forest Service, 40 p.
- Schroeder, Mark J.; Buck, Charles C.** 1970. Fire weather. Agric. Handb. 360. Washington: U.S. Department of Agriculture, Forest Service. 229 p.
- Seigel, William C. 1985. Legal implications of prescribed burning in the South. In: Proceedings on Prescribed Fire and Smoke Management in the South Conference; 1984 September 12-14; Atlanta, GA. Asheville, NC: U.S. Department of Agriculture, Forest Service, Southeastern Forest Experiment Station: 77- 85.
- Tiedemann, Arthur R. (and others).** 1979. Effects of fire on water: a state of knowledge review. Gen. Tech. Rep. WO-10. Washington: U.S. Department of Agriculture, Forest Service. 28 p.
- U.S. Department of Agriculture, Forest Service, Southeastern Forest Experiment Station.** Prescribed burning symposium. 1971 April 14-16. Charleston SC. Asheville, NC. 160 p.
- U.S. Department of Agriculture, Forest Service, Southeastern Forest Experiment Station.** 1976. Southern forestry smoke management guidebook. Gen. Tech. Rep. ♪ Asheville, NC. 140 p.
- U.S. Department of Agriculture, Forest Service.** 1977. Fire by prescription symposium; 1976 October 13-15; Atlanta. Washington. 127 p.
- U.S. Department of Agriculture, Forest Service, Southeastern Forest Experiment Station.** 1985. Prescribed fire and smoke management in the South: Proceedings of a symposium; 1984 September 12-14; Atlanta, GA. Asheville, NC. 194 p.

U.S. Department of Agriculture,
Forest Service, Southern Region.
1988. Draft environmental impact
statement: vegetation management in
the Coastal Plain/Piedmont. Vol. I and
II. Marge. Bull. R8-MB 15. Atlanta.

Van Lear, D.H; Danielovich, S.J.
1988. Soil movement after broadcast
burning in the southern Appalachians.
Southern Journal of Applied Science.
12(1): 49-53.

Villarrubia, CR.; Chambers J.L.
1978. Fire, its effect on growth and
survival of loblolly pine, *Pinus taeda*
L. Louisiana Academy of Science. 41:
85-93.

Wade, Dale D. 1983. Fire
management in the slash pine
ecosystem. In: Proceedings, the
managed slash pine ecosystem. 1981
June 9-11; Gainesville, FL.
Gainesville, FL: University of
Florida, School of Forest Resources
and Conservation, 203-227, 290-294,
301.

Wade Dale D. 1986. Linking fire
behavior to its effects on living plant
tissue. In: Proceedings of the 1986
Society of American Foresters
National Convention; 1986 October
5-8; Birmingham, AL. Bethesda,
MD: Society of American Foresters.
112-116.

Wade, Dale D.; Johansen, R.W.1986.
Effects of fire on southern pine:
observations and recommendations.
Gen. Tech. Rep. SE-41. Asheville,
NC: U.S. Department of Agriculture,
Forest Service, Southeastern Forest
Experiment Station. 14 p.

Wade, Dale D.; Lewis, Clifford E.
1987. Managing southern grazing
ecosystems with fire. Rangelands.
9(3): 115-119.

Wade, Dale D.; Wilhite, Lawrence P.
1981. Low intensity burn prior to
bedding and planting slash pine is of
little value. In: Proceedings, 1st
southern silvicultural research
conference; 1980 November 6-7;
Atlanta, GA. Gen. Tech. Rep. SO-34.
New Orleans: U.S. Department of
Agriculture, Southern Forest
Experiment Station: 70-74.

Waldrop, Thomas A. (and others).
1987. Long term studies of prescribed
burning in loblolly pine forests of the
Southeastern Coastal Plain. Gen.
Tech. Rep. SE-45. Asheville, NC:
U.S. Department of Agriculture,
Forest Service, Southeastern Forest
Experiment Station. 23 p.

Weise, David R.; Johansen, R.W.;
Wade, Dale D. 1987. Effects of spring
defoliation on first-year growth of
young loblolly and slash pines. Res.
Note SE-347. Asheville, NC: U.S.
Department of Agriculture, Forest
Service, Southeastern Forest
Experiment Station. 4 p.

Wells, Carol G. (and others). 1979.
Effects of fire on soil: a state of
knowledge review. Gen. Tech. Rep.
WO-7. Washington: U.S. Department
of Agriculture, Forest Service. 34 p.

For information about articles,
contact: USDA Forest Service,
Southern Region, Fire and Aviation
Staff Unit, 1720 Peachtree Road NW,
Atlanta, GA 30367 or USDA Forest
Service, Southeastern Forest
Experiment Station, P.O. Box 2680,
Asheville, NC 28802

Five Steps to a Successful Prescribed Burn



ANALYSIS



PRESCRIPTION



PREPARATION



EXECUTION



EVALUATION



The Forest Service, U.S. Department of Agriculture, is responsible for Federal leadership in forestry. It carries out this role through four main activities:

Protection and management of resources on 191 million acres of National Forest System lands.

- Cooperation with State and local governments, forest industries, and private landowners to help protect and manage non-Federal forest and associated range and watershed lands.
- Participation with other agencies in human resource and community assistance programs to improve living conditions in rural areas.
- Research on all aspects of forestry, rangeland management, and forest resources utilization.

The Southern Region

- Represents the National Forest System and the State and Private Forestry branches of the Forest Service in Alabama, Arkansas, Florida, Georgia, Kentucky, Louisiana, Mississippi, North Carolina, Oklahoma, Puerto Rico, South Carolina, Tennessee, Texas, Virginia, and U.S. Virgin Islands.

U.S. DEPARTMENT OF AGRICULTURE
FOREST SERVICE, SOUTHERN REGION
1720 PEACHTREE ROAD, NW
ATLANTA, GEORGIA 30367-9102